

**Messing chemisch
vernickelt**

Verschraubungen

























**Laiton avec
nickelage chimique**

Raccords

**Brass chemically
nickel-plated**

Unions



	Seite/Page/Page		Seite/Page/Page		Seite/Page/Page
Klemmring Bague de serrage Compression ferrule	8.4 	Gerade Einschraubverschraubung Union mâle Male adaptor union	8.14 	Winkel-Einschraubverschraubung Coude mâle Male adaptor elbow union	8.23 
	SO 80001		SO 81121		SO 82421
Abschlusszapfen Bouchon d'arrêt Plug	8.6 	Gerade Einschraubverschraubung Union mâle Male adaptor union	8.15 	Einstellwinkel Coude orientable Adjustable elbow union	8.24 
	SO 80002		SO 81124		SO 82621
Stützhülse Douille d'appui Stiffener sleeve	8.7 	Gerade Aufschraubverschraubung Union simple femelle Female adaptor union	8.17 	Winkel-Schottverschraubung Union double pour passage de cloison Panel mount union	8.25 
	SO 80003		SO 81221		SO 82721
Armaturenanschluss Ecrou de raccordement Nut connection	8.8 	Verbindungsrippel Pièce folle Tube stub	8.18 	T-Verschraubung Té Tee union	8.25 
	SO 80021		SO 81300		SO 83021
Übergangsmuffe Adapteur femelle Female adaptor	8.10 	Gerade Schottverschraubung Union double Panel mount union	8.19 	T-Verschraubung mit Einstellzapfen Té orientable Adjustable tee union	8.26 
	SO 80030		SO 81521		SO 83621 T
Übergangsrippel Adapteur mâle Male adaptor	8.11 	Einstellrippel Union orientable mâle Adjustable male adaptor	8.20 	L-Verschraubung L orientable Adjustable L union	8.26 
	SO 80040		SO 81600		SO 83621 L
Schlauchtülle Douille cannelée pour tuyau Hose nozzle	8.12 	Reduktionsverschraubung Réduction Reduction union	8.21 	Einschraub-T Té mâle Male adaptor Tee union	8.27 
	SO 80503		SO 81821		SO 83721 T
Gerade Verschraubung Union double Straight union	8.13 	Winkelverschraubung Coude Elbow union	8.22 	Reduziermuffe Réduction femelle-femelle Female reduction socket	8.28 
	SO 81021		SO 82021		SO 80031

Seite/Page/Page

Reduziernippel
Réduction femelle-mâle
Male reduction nipple



8.28

Alle Produkte aus dem Kapitel 4 sind auf Wunsch mit Aufpreis in chem. vernickelter Ausführung erhältlich.

SO 80041

Tous les produits du chapitre 4 sont aussi réalisables en nickelé chimique avec un supplément.

Verschlusschraube
Bouchon d'obturation
Screw plug



8.29

All products in chapter 4 are available chemically nickel plated for an additional charge.

SO 80371

Einschraubtülle
Douille cannelée à visser
Male adaptor hose nozzle



8.29

SO 80511

Sonderausführungen:

Exécution en option:

Optional Services:



Spezialbehandlung für Einsatz mit Sauerstoff
Traitement spécial pour utilisation sous oxygène
Special treatment for use with oxygen



Spezialbehandlung - silikonfrei
Traitement spécial - sans silicone
Special treatment - silicone free



Spezialreinigung - entfettet
Traitement spécial - sans silicone
Special treatment - degreased



Vorbeschichtete Gewinde mit Loctite 5061
Filetages pré enduits avec Loctite 5061
Pre-coated threads with Loctite 5061



Vorbeschichtete Gewinde PTFE-Band umwickelt
Filetages pré enduits avec ruban en PTFE
Pre-coated threads with PTFE-tape

Sonderausführung für Adapter
siehe Kapitel 9

Exécution en option pour adaptateurs
voir chapitre 9

Option services for adaptors
see chapter 9

Messing CV

Eigenschaften, Besonderheiten

- einfache, schnelle Montage
- kompakte Baumasse
- grosse Sortimentsvielfalt
- sehr viele Kombinationsmöglichkeiten

Funktionsprinzip

siehe Anhang

Basis-Werkstoff

Messing CuZn40Pb2 (CW 617N)

Chemische Vernickelung

Nickel:	88 - 89,5 %
Phosphor:	10,5 - 12 %
Schmelzpunkt:	ca. +880°C
Härtegrad:	450/500 Vickers

Schichtstärke

Generell:	ca. 7 µm
Ausnahme:	Ventilspindeln ca. 2 µm

Nenndruck PN

Der Nenndruck **PN** ist mit 4-facher Sicherheit in **bar** bei statischer Belastung und in den technischen Tabellen **für jeden Rohrdurchmesser individuell** aufgeführt.

Temperaturbereich

-40°C bis +180°C

Vakuum

Bis 10⁻⁴ mbar, höhere Werte möglich

Anzuschliessende Kupferrohre

Nahtlose, gezogene Kupferrohre (insbes. EN 12449/1057) mit sauberer, glatter Oberfläche. Aussendurchmesser innerhalb ± 0,1 mm. Alle dünnwandigen Kupferrohre, welche gemäss der Tabelle im Anhang mit einem ★ versehen sind, müssen mit Stützhülsen verstärkt werden.

Anzuschliessende Edelstahlrohre

Nahtlose Präzisionsrohre aus Edelstahl (DIN EN 10216-5/EN ISO 1127, Toleranzkl. T4) mit sauberer, glatter Oberfläche. Aussendurchmesser innerhalb ± 0,1 mm. Oberflächenbeschaffenheit mindestens m, Härte ≤ HRB 80 ≈ HV 155.

Wichtig!

Chemisch vernickelte Verschraubungen können im Einzelfall als günstigere Variante zu Edelstahl eingesetzt, jedoch keinesfalls als allgemeine Alternative betrachtet werden. Jede Anwendung ist unter Berücksichtigung der Einsatzbedingungen (Druck, Medium, Temperatur, Umgebung, etc.) individuell abzuklären. Wir empfehlen bei Bedarf vorgängig eigene Tests durchzuführen oder sich unter Angabe der genauen Einsatzbedingungen an uns zu wenden.

Lation CV

Généralités

- montage facile et rapide
- compactes dimensions
- programme étendu
- multiples possibilités de combinaisons

Principe de fonctionnement

voir annexe

Matériau de base

Laiton CuZn40Pb2 (CW 617N)

Nickelage chimique

Nickel:	88 - 89,5 %
Phosphore:	10,5 - 12 %
Point de fusion:	ca. +880°C
Dureté:	450/500 Vickers

Epaisseur de la couche

Général:	env. 7 µm
Exception:	tige du robinet ca. 2 µm

Pression nominale PN

La pression nominale **PN** est indiquée en **bar** avec un coefficient de sécurité 4 à une charge statique et est présentée dans des tableaux techniques **pour tous les diamètres individuels**.

Plage de température admissible

-40°C à +180°C

Vide

Jusqu'à 10⁻⁴ mbar, plus poussé possible

Tubes en cuivre à utiliser

Tubes en cuivre sans soudure (selon EN 12449/1057) avec surface propre et lisse. Le diamètre extérieur doit être situé dans une tolérance de ± 0,1 mm. Tous les tubes en cuivre à paroi mince repérés ★ sur le tableau dans l'annexe doivent être renforcés par des douilles d'appui.

Tubes en acier inox à utiliser

Tubes en acier inoxydable sans soudure (selon DIN EN 10216-5/EN ISO 1127, classe de tolérance T4), avec surface propre et lisse. Le diamètre extérieur doit se situer dans une tolérance de ± 0,1 mm. Qualité de la surface en minimum m, dureté ≤ HRB 80 ≈ HV 155.

Important!

Dans certains cas d'application, les vissages nickelés peuvent représenter une variante plus économique que les alliages inoxydables. Le domaine d'utilisation n'est cependant pas universel. Chaque utilisation devra donc faire l'objet d'une considération des conditions présentes (pression, fluide, température, environnement, etc.). Il est conseillé d'effectuer, si nécessaire, des tests préalables, ou le cas échéant, de prendre contact avec nous, en indiquant les conditions d'environnement de la manière la plus précise possible.

Brass CV

Characteristics, specialities

- easy and fast to install
- compact dimensions
- extensive range
- many combination possibilities

Operating principle

see appendix

Basic-Material

Brass CuZn40Pb2 (CW 617N)

Chemical nickel-plating

Nickel:	88 - 89,5 %
Phosphorus:	10,5 - 12 %
Melting point:	ca. +880°C
Degree of hardness:	450/500 Vickers

Thickness of the layer

Generally:	ca. 7 µm
Exception:	valve spindles ca. 2 µm

Nominal pressure PN

The nominal pressure **PN** is indicated in **bar** with a safety factor of 4 at static load and shown in the technical product tables **for each individual diameters**.

Temperature range

-40°C to +180°C

Vacuum

Up to 10⁻⁴mbar, higher values are possible

Copper tubes to use

Seamless copper tubes (esp. EN 12449/1057) with clean smooth surface. Outside diameter of ± 0,1 mm. All thin-walled copper tubes as marked ★ on the table in the appendix must be reinforced with stiffener sleeves.

Stainless steel tubes to use

Seamless stainless steel precision tubes (to DIN EN 10216-5/EN ISO 1127, tolerance class T4) with clean smooth surface. Outside diameter of ± 0,1 mm. Minimum quality of the surface: m, hardness ≤ HRB 80 ≈ HV 155.

Important!

Chemical nickel-plated unions can be used as a less expensive alternative to stainless steel in individual cases, but under no circumstances as a general rule. The working conditions (pressure, medium, temperature, environment etc.) have to be established for each individual application. To the extent required we recommend that you carry out your own tests beforehand, or that you consult us with indication of the exact working conditions.

Klemmring
Bague de serrage
Compression ferrule

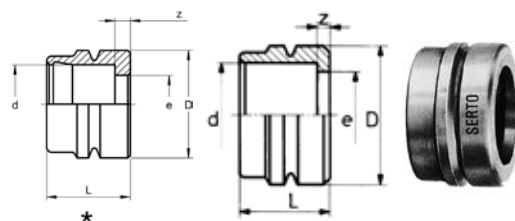

SO 80001

Type -d	Mat.-Nr.	bar	L	D	z	e	kg/100
SO 80001-4	036.0010.040	125	5.0	6.0	1.0	3.5	0.060
SO 80001-5	036.0010.050	125	5.5	6.8	1.0	4.0	0.060
SO 80001-6 *	036.0010.060	200	6.5	8.4	1.2	4.0	0.120
SO 80001-8 *	036.0010.080	125	7.0	10.5	1.2	6.5	0.170
SO 80001-10 *	036.0010.100	80	7.8	12.7	1.2	8.5	0.250
SO 80001-12 *	036.0010.120	80	8.8	14.7	1.2	10.0	0.330
SO 80001-15	036.0010.150	25	10.0	18.0	1.4	13.0	0.510
SO 80001-18	036.0010.180	25	11.7	22.0	1.4	16.0	0.910

Klemmring reduziert
Bague de serrage de réduction
Reduction compression ferrule

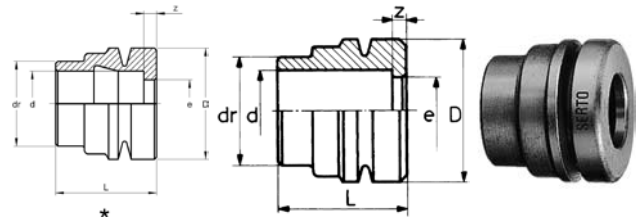

SO 80001 RED

Type -dr -d	Mat.-Nr.	bar	L	D	dr	z	e	kg/100
SO 80001-6-4 RED	036.0014.110	100	8.5	8.5	6.00	1.0	3.5	0.230
SO 80001-8-6 RED *	036.0014.140	125	9.5	10.5	8.00	1.2	4.5	0.330
SO 80001-10-8 RED *	036.0014.190	125	11.5	12.7	10.00	1.2	6.5	0.450
SO 80001-12-10 RED *	036.0014.240	80	12.5	14.7	12.00	1.2	8.5	0.610
SO 80001-15-12 RED	036.0014.420	40	14.0	18.0	15.00	1.4	10.0	1.050
SO 80001-18-15 RED	036.0014.610	25	15.7	22.0	18.00	1.4	13.0	1.660

Anwendungsbeispiele:

Exemples d'utilisation:

Sample combinations:

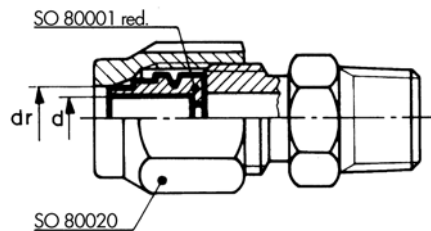

Einstufige Reduktionen von Rohranschlüssen sind auf einfachste Art durch Auswechseln der normalen gegen die reduzierten Klemmringe möglich.

Beispiel:

Reduktion eines Rohranschlusses

ø 15 auf 12 mm:

Klemmring SO 80001 - 15 austauschen gegen

Klemmring SO 80001 - 15 - 12 RED.

Anschlussmutter SO 80020 - 15 bleibt.

Le raccordement de tubes réduits d'une dimension peut s'effectuer très simplement en échangeant la bague de serrage normale contre une bague de réduction.

Exemple:

Réduction d'un raccord ø 15 à 12 mm:

Echanger la bague de serrage SO 80001 - 15

contre une bague de réduction

SO 80001 - 15 - 12 RED.

L'écrou SO 80020 - 15 reste le même.

Single stage tube reduction connections are easily made by replacing the standard compression ferrule with a reduction compression ferrule.

Example:

Tube reduction connection 15 to 12 mm dia.:

Replace compression ferrule SO 80001 - 15

by compression ferrule

SO 80001 - 15 - 12 RED.

Union nut SO 80020 - 15 remains.

Abschlusszapfen
Bouchon d'arrêt
Plug

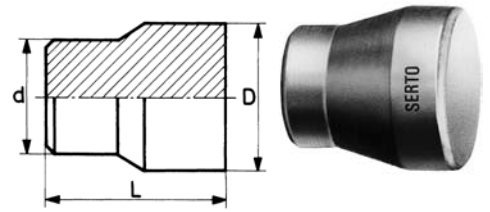

SO 80002

Type -d	Mat.-Nr.	L	D	kg/100
SO 80002-6	036.0020.060	10.0	8.4	0.310
SO 80002-8	036.0020.080	10.5	10.5	0.570
SO 80002-10	036.0020.100	13.0	12.7	0.960
SO 80002-12	036.0020.120	14.0	14.8	1.470
SO 80002-15	036.0020.150	15.0	18.0	2.370
SO 80002-18	036.0020.180	16.8	22.0	4.000
SO 80002-6,35	036.0020.063	10.0	8.4	0.310

Anwendungsbeispiele:

Exemples d'utilisation:

Sample combinations:

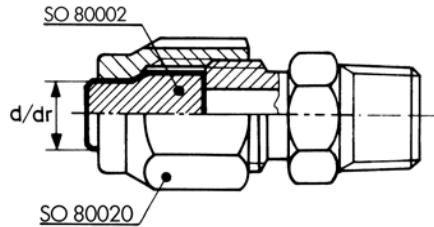

Werkstoff: Messing

Der Abschlusszapfen SO 80002 lässt sich in jede Verschraubung anstelle eines Klemmringes gleicher Größe d einsetzen.

Wird ein Klemmring SO 80001 RED durch einen Abschlusszapfen SO 80002-d ersetzt, so muss immer von der Größe dr der Anschlussmutter SO 80020 ausgegangen werden.

Anschlussmutter mit 1/4 Umdrehung anziehen.

Matériau: Laiton

Le bouchon d'arrêt SO 80002 peut remplacer la bague de serrage de même dimension d dans chaque raccord.

Dans le cas où un bouchon d'arrêt SO 80002-d remplace une bague de serrage SO 80001 RED il faut toujours se baser sur la dimension dr de l'écrou SO 80020.

Serrer l'écrou avec 1/4 tour.

Material: Brass

The plug SO 80002 can be fitted into any union in place of a compression ferrule of same diameter d.

If a reduction ferrule SO 80001 RED is replaced by a plug SO 80002-d, the change must always be governed by the dimension dr of the union nut SO 80020.

Tighten the union nut with 1/4 turn.

Stützhülse

Bussola di rinforzo

Stiffener sleeve

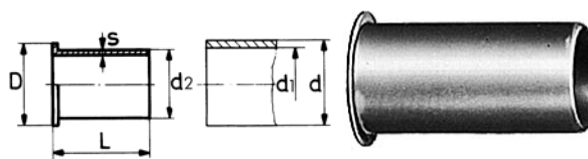

SO 80003

Type -d-d1	Mat.-Nr.	L	D	s	kg/100
SO 80003-6-4	036.0030.110	10.0	5.5	0.20	0.025
SO 80003-8-6	036.0030.140	12.0	7.5	0.25	0.045
SO 80003-10-8 D	036.0030.189	16.0	9.5	0.60	0.190
SO 80003-10-8	036.0030.190	16.0	9.5	0.30	0.100
SO 80003-12-10	036.0030.240	20.0	11.5	0.40	0.195
SO 80003-15-13	036.0030.430	24.0	14.5	0.50	0.390
SO 80003-17-15	036.0030.610	26.0	16.5	0.60	0.590
SO 80003-18-15	036.0030.540	26.0	16.5	0.60	0.590

Werkstoff: Messing, chemisch vernickelt
Verstärken:

Dünnwandige und weiche Rohre sowie alle Kunststoffrohre sind vor dem Einführen in die SERTO-Verschraubung mit Stützhülsen zu verstärken.

Genauere Angaben über das Verstärken sind den einzelnen Verschraubungsreihen im Anhang zu entnehmen.

Zum Entgraten und Kalibrieren der Rohre eignen sich besonders unsere Hilfswerkzeuge.

Materiale: Ottone nichelato chimicamente
Rinforzo:

I tubi che presentano una parete sottile o che sono realizzabili in materiale tenero ed i tubi in materiale plastico, devono essere rinforzati con bussole di rinforzo prima di essere inseriti nei raccordi SERTO.

Dati più precisi relativi al rinforzo vengono forniti nelle sezioni relative al modello corrispondente nell'appendice.

La sbavatura e la calibratura del tubo vengono facilitate dai nostri attrezzi speciali.

Material: Brass, chemically nickel-plated
Reinforcement:

Thin walled and soft tubes, and all plastic tubes, are to be reinforced with stiffener sleeves before introducing them into the SERTO union.

Exact details concerning stiffening are to be found in the sections on the relevant model series in the appendix.

Our tools are especially useful for deburring and calibrating tubing.

Sechskantmutter

Dado esagonale

Hexagon nut

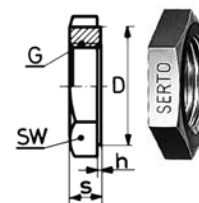

SO 80006 METR

Type -G	Mat.-Nr.	SW	D	h	s	kg/100
Für metrische Rohre	Per tubi in unità metrica		For metric tubes			
G=Rohrgewinde (zylindrisch)	G=Filettatura BSP (cilindrica)		G=BSP thread (straight)			
SO 80006-M10X1	036.0063.150	14	13.8	0.5	4.00	0.310
SO 80006-M12X1	036.0063.190	17	16.8	0.5	4.00	0.460
SO 80006-M14X1	036.0063.220	19	18.8	0.5	4.00	0.530
SO 80006-M16X1	036.0063.260	19	18.8	0.5	4.00	0.380
SO 80006-M20X1	036.0063.340	24	23.8	0.5	4.50	0.690
SO 80006-M20X1,5	036.0063.345	27	26.8	0.5	6.00	1.640
SO 80006-M24X1,5	036.0063.405	27	26.8	0.5	7.00	1.140

Sechskantmutter für SO 81521 und Ventile

Dado esagonale per SO 81521 e valvole

Hexagon nut for SO 81521 and valves

d=Rohraussen-ø
d1=Rohrinnendurchmesser
s= Wandstärke

d=diametro esterno del tubo
d1=diametro interno del tubo
s=spessore parete

d=tube outside diameter
d1=tube inside diameter
s=wall thickness

Anschlussmutter

Ecrou

Union nut

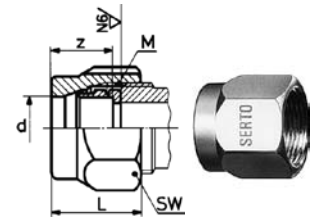

SO 80020

Type -d	Mat.-Nr.	bar	M	L	kg/100
SO 80020-6	036.0200.060	200	10 x 1	14.5	0.740
SO 80020-8	036.0200.080	125	12 x 1	16.0	0.990
SO 80020-10	036.0200.100	80	14 x 1	18.5	1.770
SO 80020-12	036.0200.120	80	16 x 1	19.5	2.170
SO 80020-15	036.0200.150	25	20 x 1.5	21.0	3.910
SO 80020-18	036.0200.180	25	20 x 1.5	23.0	4.370

Armaturenanschluss

Ecrou de raccordement

Nut connection

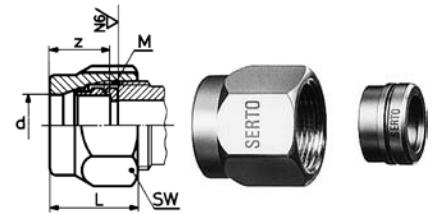

SO 80021

Type -d	Mat.-Nr.	bar	M	SW	L	z	kg/100
SO 80021-6	036.0210.060	200	10 x 1	12	14.5	7.5	0.840
SO 80021-8	036.0210.080	125	12 x 1	14	16.0	8.0	1.120
SO 80021-10	036.0210.100	80	14 x 1	17	18.5	10.0	1.890
SO 80021-12	036.0210.120	80	16 x 1	19	19.5	11.0	2.340
SO 80021-15	036.0210.150	25	20 x 1.5	24	21.0	12.5	4.240
SO 80021-18	036.0210.180	25	24 x 1.5	27	23.0	14.0	5.260

Anschlussmutter SO 80020 mit Klemmring
SO 80001

Ecrou SO 80020 avec bague de serrage
SO 80001

Union nut SO 80020 with compression
ferrule SO 80001

Armaturenanschluss reduziert
Ecrou de raccordement réduit
Reduction tube connection

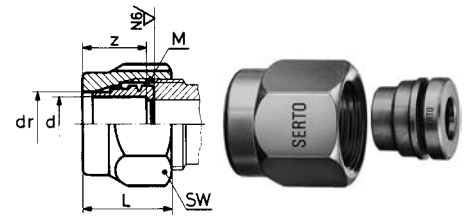

SO 80021 RED

Type -dr -d red	Mat.-Nr.	bar	M	SW	L	dr	z	kg/100
SO 80021-6-4 RED	036.0214.110	100	10 x 1	12	14.5	6.00	7.5	0.950
SO 80021-8-6 RED	036.0214.140	125	12 x 1	14	16.0	8.00	8.0	1.280
SO 80021-10-8 RED	036.0214.190	125	14 x 1	17	18.5	10.00	10.0	2.090
SO 80021-12-10 RED	036.0214.240	80	16 x 1	19	19.5	12.00	11.0	2.620
SO 80021-15-12 RED	036.0214.420	40	20 x 1.5	24	21.0	15.00	12.5	4.780
SO 80021-18-15 RED	036.0214.610	25	24 x 1.5	27	23.0	18.00	14.0	6.010

Anwendungsbeispiele:

Exemples d'utilisation:

Sample combinations:

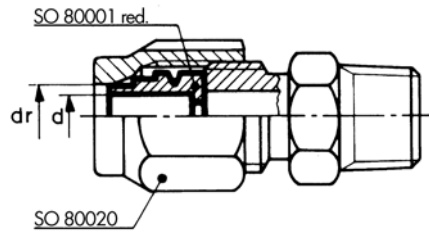

Anschlussmutter SO 80020 mit Klemmring reduziert SO 80001 RED.
 Mit diesem Armaturenanschluss können einstufige Reduktionen vorgenommen werden. Gewindezapfen für SERTO-Anschlüsse siehe Anhang.

Ecrou SO 80020 avec bague de serrage de réduction SO 80001 RED.
 Ces écrous de raccordement permettent d'effectuer des réductions d'une dimension.
 Embout fileté pour écrous de raccordement SERTO voir annexe.

Union nut SO 80020 with reduction compression ferrule SO 80001 RED.
 This reduction tube connection permits single stage reductions to be made.
 Threaded stem for SERTO connections please see appendix.

d=Rohrassens-ø
 dr= Grösse der Anschlussmutter
 z= Mass in montiertem Zustand

d=ø extérieur du tube
 dr= Dimension de l'écrou de base
 z=après montage

d=tube outside diameter
 dr=Size of the connection nut
 z=installed length

Übergangsmuffe Adapteur femelle Female adaptor

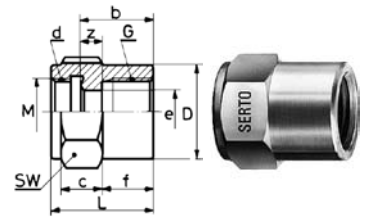

SO 80030

Type -d-G	Mat.-Nr.	bar	M	SW	L	b	c	D	f	z	e	kg/100
G=Rohrgewinde (zylindrisch)												
G=Filetage-gaz BSP (cylindrique)												
G=BSP thread (straight)												
SO 80030-6-1/8	036.0301.100	200	10 x 1	14	20.0	14.0	8.0	13.8	10.0	4.0	5.0	1.670
SO 80030-6-1/4	036.0301.110	200	10 x 1	17	21.0	15.0	8.0	16.8	11.0	4.0	5.0	2.530
SO 80030-8-1/8	036.0301.160	125	12 x 1	17	21.0	14.0	9.0	16.8	10.0	4.0	6.5	2.790
SO 80030-8-1/4	036.0301.170	125	12 x 1	17	23.0	16.0	9.0	16.8	12.0	5.0	6.5	2.540
SO 80030-10-1/4	036.0301.270	80	14 x 1	17	22.0	15.0	8.0	16.8	12.0	4.0	8.5	2.090
SO 80030-10-3/8	036.0301.280	80	14 x 1	22	23.0	17.0	10.0	21.8	11.0	5.0	8.5	4.760
SO 80030-12-3/8	036.0301.390	80	16 x 1	22	23.0	16.0	10.0	21.8	11.0	4.0	10.0	4.090
SO 80030-12-1/2	036.0301.400	80	16 x 1	27	25.0	18.0	11.0	26.8	12.0	4.0	10.0	7.270
SO 80030-15-1/2	036.0301.534	25	20 x 1.5	27	27.0	19.0	13.0	26.8	12.0	5.0	13.0	7.130
SO 80030-18-1/2	036.0301.646	25	24 x 1.5	30	28.0	20.0	14.0	29.8	12.0	6.0	15.0	9.410
SO 80030-18-3/4	036.0301.648	25	24 x 1.5	32	31.0	23.0	13.0	31.8	16.0	6.0	15.0	10.350

Anwendungsbeispiele:

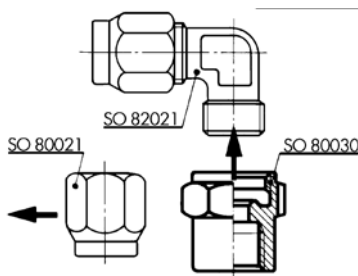

Die Übergangsmuffe SO 80030 kann an jedes SERTO-Formteil mit dem passenden zylindrischen Gewinde M aufgeschraubt werden.

Dichtungsprinzip:

Bei der Montage drückt sich die Dichtkante des Übergangsstückes in das SERTO-Formteil ein, dadurch entsteht eine einwandfreie metallische Dichtung.

Wir empfehlen, das Gewinde mit einem geeigneten Flüssigklebstoff gegen unbeabsichtigtes Lösen zu sichern.

Exemples d'utilisation:

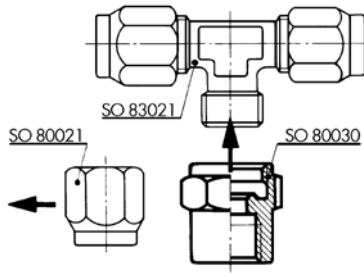

L'adaptateur femelle SO 80030 peut être monté sur toutes les pièces de forme SERTO avec le filetage cylindrique M correspondant.

Principe d'étanchéité:

Lors du serrage, le bourrelet s'enfonce dans la pièce de forme SERTO et donne un joint métallique parfait.

Nous recommandons de freiner le filetage avec une résine appropriée contre un desserrage intempestif.

Sample combinations:

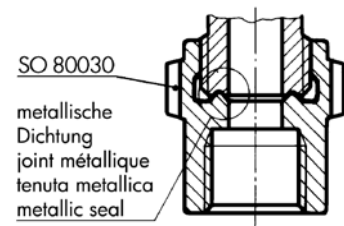

The female adaptor SO 80030 can be screwed onto every SERTO union body with the appropriate straight thread M.

Sealing principle:

On being installed, the lip of the adaptor presses into the SERTO union body, forming a sound metallic seal.

We recommend to secure the thread with a suitable cement against unintended loosening.

Übergangsnippel Adaptateur mâle Male adaptor

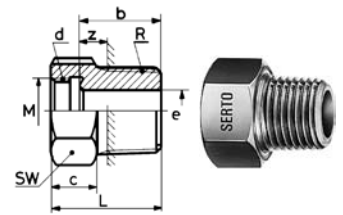

SO 80040

Type -d-R	Mat.-Nr.	bar	M	SW	L	b	c	z	e	kg/100
R=Rohrgewinde (kegelig)	R=Filetage-gaz BSP (conique)	R=BSP thread (tapered)								
SO 80040-6-1/8	036.0401.100	200	10 x 1	12	17.0	11.0	9.0	4.5	5.0	0.800
SO 80040-6-1/4	036.0401.110	200	10 x 1	14	21.0	15.0	9.0	5.3	5.0	1.850
SO 80040-8-1/8	036.0401.160	125	12 x 1	14	18.0	11.0	10.0	4.5	5.0	0.990
SO 80040-8-1/4	036.0401.170	125	12 x 1	14	22.0	15.0	10.0	5.3	6.5	1.520
SO 80040-10-3/8	036.0401.280	80	14 x 1	17	22.0	15.0	10.0	4.9	8.5	2.440
SO 80040-10-1/2	036.0401.285	80	14 x 1	22	23.0	16.0	7.0	2.8	8.5	5.030
SO 80040-12-1/4	036.0401.380	80	16 x 1	19	23.0	16.0	11.0	6.3	8.5	2.110
SO 80040-12-3/8	036.0401.390	80	16 x 1	19	23.0	16.0	11.0	6.0	10.0	2.870
SO 80040-12-1/2	036.0401.400	80	16 x 1	22	26.0	19.0	10.0	6.0	10.0	4.840
SO 80040-15-3/8	036.0401.532	25	20 x 1.5	24	24.0	16.0	12.0	6.0	10.0	3.760
SO 80040-15-1/2	036.0401.534	25	20 x 1.5	24	28.0	20.0	12.0	7.0	13.0	4.430
SO 80040-15-3/4	036.0401.536	25	20 x 1.5	27	27.5	19.5	11.0	5.0	13.0	8.250
SO 80040-18-1/2	036.0401.646	25	24 x 1.5	30	29.0	21.0	13.0	8.0	15.0	6.010
SO 80040-18-3/4	036.0401.648	25	24 x 1.5	30	29.5	21.5	13.0	7.0	15.0	8.930

Anwendungsbeispiele:

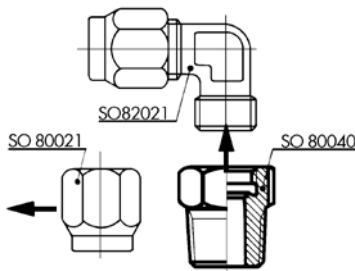

Dichtungsprinzip:

Bei der Montage drückt sich die Dichtkante des Übergangsstückes in das SERTO-Formteil ein, dadurch entsteht eine einwandfreie metallische Dichtung.

Wir empfehlen, das Gewinde mit einem geeigneten Flüssigklebstoff gegen unbeabsichtigtes Lösen zu sichern.

Exemples d'utilisation:

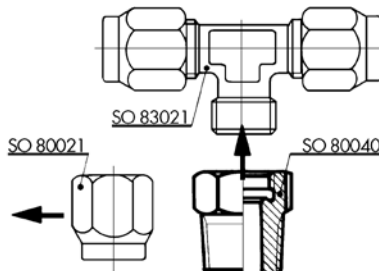

Principe d'étanchéité:

Lors du serrage, l'arête d'étanchéité s'enfonce dans la pièce de forme SERTO et donne un joint métallique parfait.

Nous recommandons de freiner le filetage avec une résine appropriée contre un desserrage intempestif.

Sample combinations:

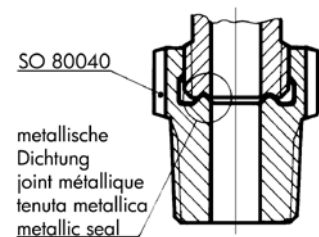

Sealing principle:

On being installed, the lip of the adaptor presses into the SERTO union body, forming a sound metallic seal.

We recommend to secure the thread with a suitable cement against unintended loosening.

Schlauchtülle

Douille cannelée pour tuyau

Hose nozzle

SO 80503

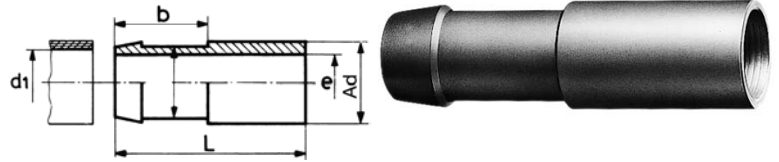

Type -Ad -d1	Mat.-Nr.	L	b	e	kg/100
SO 80503-A6-4	036.0500.110	25.0	11.0	3.0	0.270
SO 80503-A6-6	036.0500.122	31.0	17.0	4.0	0.480
SO 80503-A8-6	036.0500.140	32.5	17.0	5.0	0.520
SO 80503-A8-8	036.0500.154	32.5	17.0	6.0	0.710
SO 80503-A10-8	036.0500.190	35.0	17.0	7.0	0.720
SO 80503-A12-10	036.0500.240	37.0	19.0	8.5	1.230
SO 80503-A12-13	036.0500.260	39.0	21.0	9.0	2.889
SO 80503-A15-13	036.0500.430	41.0	21.0	11.0	2.050
SO 80503-A18-16	036.0500.620	47.0	26.0	14.0	3.240

Anwendungsbeispiele:

Mit dieser Schlauchtülle können Gummischläuche und Rohre aus Teflon, Weich-PVC, Polyamid usw. direkt an SERTO-Verschraubungen angeschlossen werden. Für die Schlauchsicherung verwenden Sie bitte unsere Schlauchklemme SO 40512.

Exemples d'utilisation:

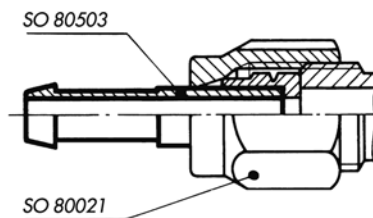

Avec cette douille cannelée, les tuyaux en caoutchouc, les tubes en téflon, en PVC souple, en polyamide et autres peuvent être fixés directement aux raccords SERTO. Afin d'assurer la bonne tenue des tuyaux, utiliser nos colliers de serrage SO 40512.

Sample combinations:

With this hose nipple, rubber hoses and plastic hoses of teflon, soft PVC, polyamide can be connected directly to the SERTO unions. Please use our hose clip SO 40512 for securing the hose.

d1=Rohrinnendurchmesser
Ad=Aussen-ø der Andrehung
e= kleinste Bohrung

d1=ø Intérieur du tube
Ad=ø extérieur de la portée cylindrique
e= ø-min. de passage

d1=tube inside diameter
Ad= outside diameter of cyl. Stub
e=minimum bore

Gerade Verschraubung
Union double
Straight union

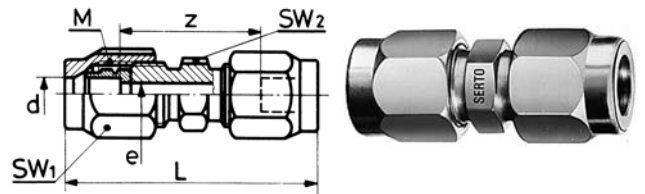

SO 81021

Type -d	Mat.-Nr.	bar	M	SW1	SW2	L	z	e	kg/100
SO 81021-6	038.1020.060	200	10 x 1	12	10	37.5	22.5	5.0	2.520
SO 81021-8	038.1020.080	125	12 x 1	14	12	41.0	26.0	6.5	3.530
SO 81021-10	038.1020.100	80	14 x 1	17	14	46.0	26.5	8.5	5.490
SO 81021-12	038.1020.120	80	16 x 1	19	17	48.5	30.0	10.0	7.030
SO 81021-15	038.1020.150	25	20 x 1.5	24	22	55.0	30.0	13.0	12.520
SO 81021-18	038.1020.180	25	24 x 1.5	27	24	59.0	31.0	15.0	15.810

Gerade Verschraubung reduziert
Union double réduite
Straight reduction union

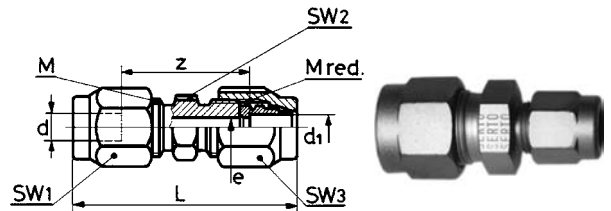

SO 81021 RED

Type -d-d1	Mat.-Nr.	bar	M	M red.	SW1	SW2	SW3	L	z	e	kg/100
* SO 81021-6-4	038.1024.110	100	10 x 1	10 x 1	12	10	12	37.5	22.5	5.0	2.630
SO 81021-8-6	038.1024.140	125	12 x 1	10 x 1	14	12	12	39.5	24.0	4.5	3.400
* SO 81021-10-8	038.1024.190	125	14 x 1	14 x 1	17	14	17	46.0	26.5	8.5	5.690
* SO 81021-12-10	038.1024.240	80	16 x 1	16 x 1	19	17	19	48.5	30.0	10.0	7.310
* SO 81021-15-12	038.1024.420	40	20 x 1.5	20 x 1.5	24	22	24	55.0	30.0	13.0	13.060
* SO 81021-18-15	038.1024.610	25	24 x 1.5	24 x 1.5	27	24	27	59.0	31.0	15.0	16.560

Weitere Reduktionen siehe SO 81821

Autres réductions voir SO 81821

Alternative reductions see SO 81821

d=Rohraussen-ø
d1=Rohrinnendurchmesser
e= kleinste Bohrung
L= Mass in montiertem Zustand
*=mit reduziertem Klemmring

d= ø extérieur du tube
d1= ø diam. Intérieur du tube
e= ø-min. de passage
L=après montage
*=avec bague de serrage de réduction

d=tube outside diameter
d1=tube inside diameter
e=minimum bore
L=installed length
*=with reduction compression ferrule

Gerade Einschraubverschraubung

Union mâle

Male adaptor union

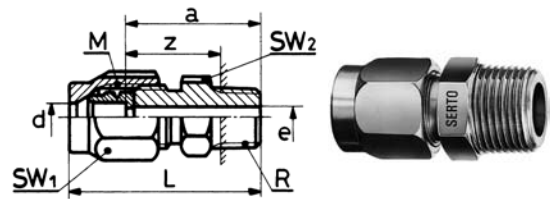

SO 81121

Type -d-R	Mat.-Nr.	bar	M	SW1	SW2	L	a	z	e	kg/100
Für metrische Rohre	Pour tubes métriques		For metric tubes							
R=Rohrgewinde (kegelig)	R=Filetage-gaz BSP (conique)		R=BSP thread (tapered)							
* SO 81121-4-1/8	038.1101.060	125	8 x 1	10	10	27.0	21.0	14.5	3.5	1.410
* SO 81121-4-1/4	038.1101.065	100	10 x 1	12	14	34.0	26.5	16.5	4.5	2.930
SO 81121-6-1/8	038.1101.100	200	10 x 1	12	10	28.5	21.0	14.5	4.5	1.690
SO 81121-6-1/4	038.1101.110	200	10 x 1	12	14	34.0	26.5	16.5	4.5	2.820
SO 81121-6-3/8	038.1101.120	200	10 x 1	12	17	34.5	27.0	20.5	4.5	3.390
SO 81121-8-1/8	038.1101.160	125	12 x 1	14	12	30.5	22.5	16.0	6.0	2.260
SO 81121-8-1/4	038.1101.170	125	12 x 1	14	14	35.5	27.5	17.5	6.5	3.110
SO 81121-8-3/8	038.1101.180	125	12 x 1	14	17	36.0	28.0	18.0	6.5	3.730
SO 81121-8-1/2	038.1101.185	125	12 x 1	14	22	41.0	33.0	20.0	6.5	6.040
SO 81121-10-1/4	038.1101.270	80	14 x 1	17	14	37.5	27.5	17.5	8.5	3.630
SO 81121-10-3/8	038.1101.280	80	14 x 1	17	17	38.0	28.0	18.0	8.5	4.830
* SO 81121-10-1/2	038.1101.285	80	16 x 1	19	22	44.0	33.0	20.0	10.0	8.040
SO 81121-12-1/4	038.1101.380	80	16 x 1	19	17	39.0	28.0	18.0	8.5	4.820
SO 81121-12-3/8	038.1101.390	80	16 x 1	19	17	39.0	28.0	18.0	10.5	5.110
SO 81121-12-1/2	038.1101.400	80	16 x 1	19	22	44.0	33.0	20.0	10.5	7.760
SO 81121-15-3/8	038.1101.532	40	20 x 1.5	24	22	43.0	30.5	20.0	10.5	8.820
SO 81121-15-1/2	038.1101.534	25	20 x 1.5	24	22	45.0	34.5	21.5	13.0	9.110
SO 81121-15-3/4	038.1101.536	25	20 x 1.5	24	27	49.5	37.0	22.5	13.0	10.650
SO 81121-18-1/2	038.1101.646	25	24 x 1.5	27	24	49.5	35.5	22.0	15.0	10.760
Für Zollrohre	Pour tubes pouces		For inch tubes							
SO 81121-6,35-1/8	038.1101.135	100	10 x 1	12	10	28.5	21.0	14.5	4.5	1.680

d=Rohrassen-ø
 e= kleinste Bohrung
 L= Mass in montiertem Zustand
 *=mit reduziertem Klemmring

d=ø extérieur du tube
 e= ø-min. de passage
 L=après montage
 *=avec bague de serrage de réduction

d=tube outside diameter
 e=minimum bore
 L=installed length
 *=with reduction compression ferrule

Gerade Einschraubverschraubung

Union mâle

Male adaptor union

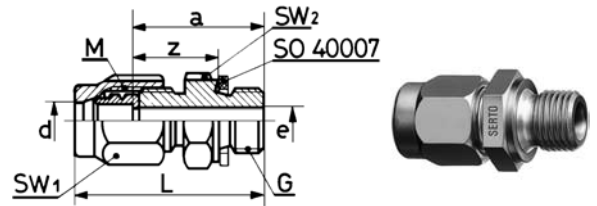

SO 81124

Type -d-G	Mat.-Nr.	bar	M	SW1	SW2	L	a	z	e	kg/100
G=Rohrgewinde (zylindrisch)	G=Filetage-gaz BSP (cylindrique)	G=BSP thread (straight)								
SO 81124-3-1/8	038.1141.040	125	6 x 0.75	8	14	25.0	20.0	12.0	2.2	1.400
SO 81124-4-1/8	038.1141.060	125	8 x 1	10	14	28.5	22.5	14.5	3.5	1.820
SO 81124-4-1/4	038.1141.065	125	10 x 1	12	19	35.5	28.0	16.0	4.5	3.840
SO 81124-5-1/8	038.1141.082	125	8 x 1	10	14	29.0	22.5	14.5	3.5	1.790
SO 81124-6-1/8	038.1141.100	200	10 x 1	12	14	30.0	22.5	14.5	4.5	2.070
SO 81124-6-1/4	038.1141.110	200	10 x 1	12	19	35.5	28.0	16.0	4.5	3.730
SO 81124-8-1/8	038.1141.160	125	12 x 1	14	14	31.5	23.5	15.5	4.5	2.830
SO 81124-8-1/4	038.1141.170	125	12 x 1	14	19	37.0	29.0	17.0	6.5	3.860
SO 81124-8-3/8	038.1141.180	125	12 x 1	14	22	38.5	30.5	18.5	6.5	5.720
SO 81124-10-1/4	038.1141.270	80	14 x 1	17	19	39.0	29.0	17.0	7.0	4.860
SO 81124-10-3/8	038.1141.280	80	14 x 1	17	22	40.5	30.5	18.5	8.5	6.250
SO 81124-12-1/4	038.1141.380	40	16 x 1	19	19	40.0	29.0	17.0	7.0	5.800
SO 81124-12-3/8	038.1141.390	40	16 x 1	19	22	41.5	30.5	18.5	10.5	6.500
SO 81124-12-1/2	038.1141.400	40	16 x 1	19	27	45.0	34.0	20.0	10.5	7.200

Gerade Einschraubverschraubung

METR

mit Dichtkante

Union mâle METR

avec arête d'étanchéité

Male adaptor union METR

with edge seal

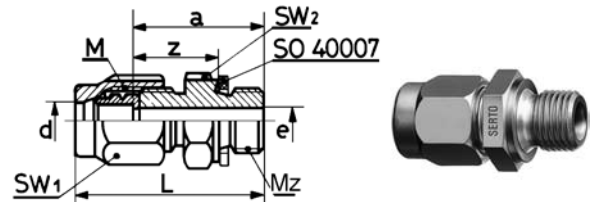

SO 81124 METR

Type -d-Mz	Mat.-Nr.	bar	M	SW1	SW2	L	a	z	e	kg/100
Mz=metrisches Gewinde (zylindrisch)	Mz=Filetage métrique (cylindrique)	Mz=Metric thread (straight)								
SO 81124-2-M5	038.1143.020	125	6 x 0.75	8	7	18.0	14.0	10.5	2.2	0.500
SO 81124-3-M5	038.1143.050	125	6 x 0.75	8	7	19.5	14.5	11.0	2.2	0.540
SO 81124-4-M8X1	038.1143.090	125	8 x 1	10	12	28.5	22.5	14.5	2.8	1.530
SO 81124-6-M10X1	038.1143.180	200	10 x 1	12	14	30.0	22.5	14.5	5.0	1.380
SO 81124-8-M12X1,5	038.1143.240	125	12 x 1	14	17	37.0	29.0	17.5	5.5	3.600

d=Rohrtaussen-ø
e= kleinste Bohrung
L= Mess in montiertem Zustand

d=ø extérieur du tube
e= ø-min. de passage
L=après montage

d=tube outside diameter
e=minimum bore
L=installed length

Gerade Einschraubverschraubung

mit O-Ringabdichtung (NBR)

Union mâle

avec joint torique (NBR)

Male adaptor union

with O-ring seal (NBR)

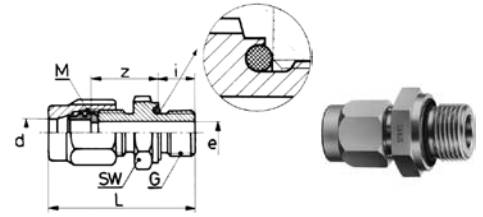

SO 81124 OR

Type - d - G	Mat.-Nr.	bar	M	SW	L	D	i	s	z	e	kg/100
Für metrische Rohre	Pour tubes métriques	For metric tubes									
G=Rohrgewinde (zylindrisch)	G=Filetage-gaz BSP (cylindrique)	G=BSP thread (straight)									
* SO 81124-4-1/8 OR	038.1171.060	100	10 x 1	14	30.0	15.0	8.0	1.00	14.5	4.0	2.300
* SO 81124-4-1/4 OR	038.1171.065	100	10 x 1	19	33.5	19.0	10.0	1.50	16.0	4.0	3.900
SO 81124-5-1/8 OR	038.1171.082	100	10 x 1	14	30.0	15.0	8.0	1.00	14.5	4.5	2.200
SO 81124-6-1/8 OR	038.1171.100	200	10 x 1	14	30.0	15.0	8.0	1.00	14.5	4.0	2.000
SO 81124-6-1/4 OR	038.1171.110	200	10 x 1	19	33.5	19.0	10.0	1.50	16.0	4.0	3.900
SO 81124-8-1/4 OR	038.1171.170	125	12 x 1	19	33.5	19.0	10.0	1.50	17.0	6.0	4.000
* SO 81124-8-3/8 OR	038.1171.180	125	14 x 1	22	38.5	23.0	10.0	2.00	18.5	8.0	6.400
SO 81124-10-1/4 OR	038.1171.270	80	14 x 1	19	37.0	19.0	10.0	1.50	17.0	6.5	4.700
SO 81124-10-3/8 OR	038.1171.280	80	14 x 1	22	38.5	23.0	10.0	2.00	18.5	8.0	6.200
SO 81124-12-3/8 OR	038.1171.390	80	16 x 1	22	39.5	23.0	10.0	2.00	18.5	10.0	6.300
SO 81124-12-1/2 OR	038.1171.400	80	16 x 1	27	42.0	27.0	12.0	2.50	19.0	10.0	7.700
SO 81124-15-1/2 OR	038.1171.534	25	20 x 1.5	27	46.0	27.0	12.0	2.50	21.5	13.0	13.500
SO 81124-18-1/2 OR	038.1171.646	25	24 x 1.5	27	47.5	27.0	12.0	2.50	21.5	13.0	15.300

Anwendungsbeispiele:

Exemples d'utilisation:

Sample combinations:

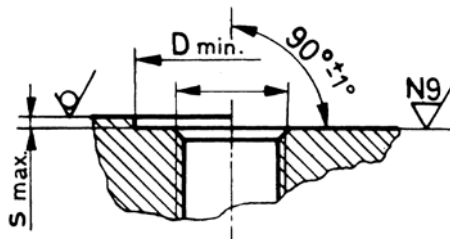

Die Vorteile von conovor® :

- keine Dichtmittelreste in Geräten
- einwandfreie Abdichtung
- keine Beschädigung von Geräten durch konische Gewinde
- schnelle Montage

Temperatur max. +100 °C

Les avantages du conovor® :

- pas de reste de produits d'étanchéité dans les appareils
- étanchéité impeccable
- pas d'endommagement des appareils par des filetages coniques
- montages rapide

Temperature max. +100 °C

The advantages of conovor® :

- no sealing compound residue in instruments
- flawless sealing
- no damage to instruments due to tapered threads
- quick installing

Temperatur max. +100 °C

d=Rohrassen-ø
e= kleinste Bohrung
L= Mass in montiertem Zustand
*=mit reduziertem Klemmring

d=ø extérieur du tube
e= ø-min. de passage
L=après montage
*=avec bague de serrage de reduction

d=tube outside diameter
e=minimum bore
L=installed length
*=with reduction compression ferrule

Gerade Aufschraubverschraubung

Union simple femelle

Female adaptor union

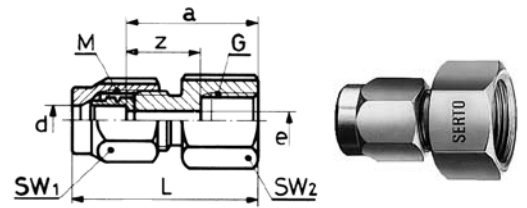

SO 81221

Type -d-G	Mat.-Nr.	bar	M	SW1	SW2	L	a	z	e	kg/100
Für metrische Rohre	Pour tubes métriques		For metric tubes							
G=Rohrgewinde (zylindrisch)	G=Filetage-gaz BSP (cylindrique)		G=BSP thread (straight)							
* SO 81221-4-1/4	038.1201.065	100	10 x 1	12	17	31.5	24.0	13.0	5.0	3.110
SO 81221-6-1/8	038.1201.100	200	10 x 1	12	14	29.5	22.0	12.0	5.0	2.360
SO 81221-6-1/4	038.1201.110	200	10 x 1	12	17	31.5	24.0	13.0	5.0	3.000
SO 81221-8-1/4	038.1201.170	125	12 x 1	14	17	32.5	24.5	13.5	6.5	2.430
SO 81221-10-1/4	038.1201.270	80	14 x 1	17	17	34.5	24.5	13.5	8.5	4.180
SO 81221-10-3/8	038.1201.280	80	14 x 1	17	22	35.5	25.5	13.5	8.0	5.900
* SO 81221-10-1/2	038.1201.285	80	16 x 1	19	27	38.0	28.0	14.0	10.0	9.060
SO 81221-12-1/4	038.1201.380	80	16 x 1	19	17	35.5	24.5	13.5	10.0	4.790
SO 81221-12-1/2	038.1201.400	80	16 x 1	19	27	39.0	28.0	14.0	10.0	8.780
SO 81221-15-1/2	038.1201.534	25	20 x 1.5	24	27	42.5	30.0	16.0	13.0	11.520
SO 81221-15-3/4	038.1201.536	25	20 x 1.5	24	32	45.5	33.0	16.0	13.0	13.640
SO 81221-18-1/2	038.1201.646	25	24 x 1.5	27	27	44.0	30.0	16.0	15.5	12.750

d=Rohrassen-ø
 e= kleinste Bohrung
 L= Mass in montiertem Zustand
 *=mit reduziertem Klemmring

d=ø extérieur du tube
 e= ø-min. de passage
 L=après montage
 *=avec bague de serrage de reduction

d=tube outside diameter
 e=minimum bore
 L=installed length
 *=with reduction compression ferrule

Verbindungsrippel

Pièce folle

Tube stub

SO 81300

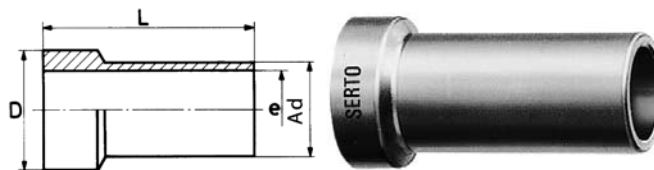

Type -Ad	Mat.-Nr.	bar	L	D	e	kg/100
SO 81300-A6	038.1300.060	200	19.0	8.4	4.0	0.350
SO 81300-A8	038.1300.080	125	21.5	10.5	6.0	0.520
SO 81300-A10	038.1300.100	80	25.5	12.7	8.0	0.850
SO 81300-A12	038.1300.120	80	27.5	14.7	9.0	1.400
SO 81300-A15	038.1300.150	25	31.0	18.0	12.0	2.100
SO 81300-A18	038.1300.180	25	35.5	22.0	15.0	3.200

Anwendungsbeispiele:

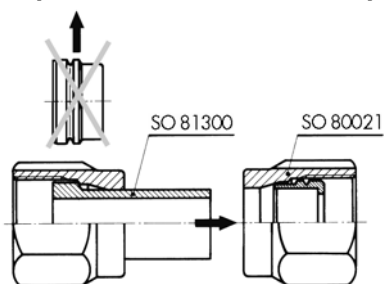

Die Verbindungsrippel SO 81300 montiert mit Anschlussmutter SO 80020 d und Armaturenanschluss SO 80021 d ergibt eine einstellbare Kupplung.

Exemples d'utilisation:

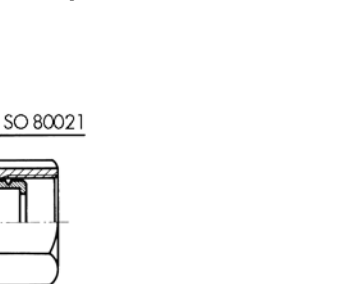

La pièce folle SO 81300 montée avec les écrous SO 80020 d et SO 80021 d donne une union orientable.

Sample combinations:

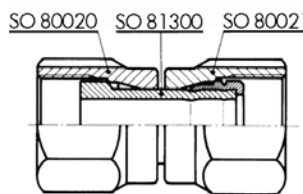

The tube stub SO 81300 assembled together with the union nut SO 80020 d and the nut connection SO 80021 d provides an adjustable coupling.

Anwendungsbeispiele:

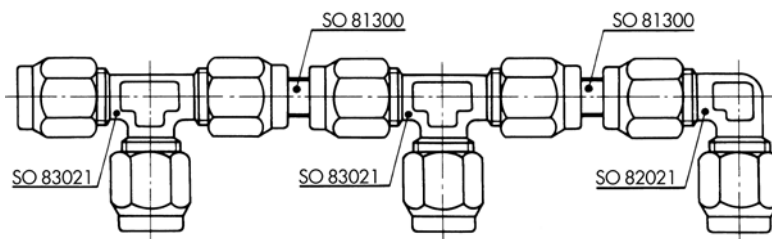

Mit der einstellbaren Kupplung lassen sich alle Formteile mit dem gleichen Anschlussgewinde M verbinden. Weitere einstellbare Verschraubungen siehe SO 81600, SO 82621, SO 83621.

Exemples d'utilisation:

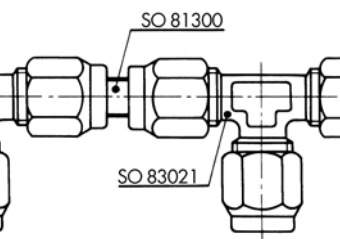

L'union orientable permet l'assemblage de tous les raccords de même filetage mâle M. Autres raccords orientables, voir SO 81600, SO 82621, SO 83621.

Sample combinations:

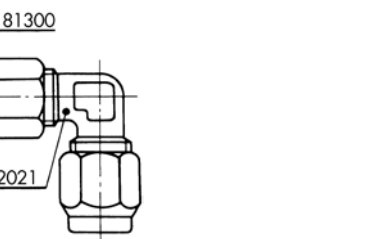

The adjustable coupling permits the connection of all fittings with the same connector thread M. See SO 81600, SO 82621, SO 83621 for other adjustable unions.

Ad=Aussen-ø der Andrehung
e=kleinste Bohrung

Ad=ø extérieur de la portée cylindrique
e=ø-min. de passage

Ad = outside diameter of cyl. stub
e=minimum bore

Gerade Schottverschraubung

Durchführungslänge max.5 mm

Union double

pour passage de cloison, Pour cloison max.5 mm

Panel mount union

max. panel thickness 5 mm

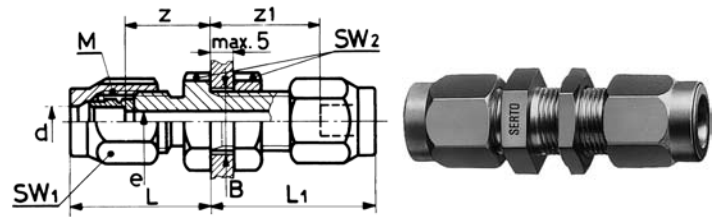

SO 81521

Type -d	Mat.-Nr.	bar	M	SW1	SW2	L	L1	B	z1	z	e	kg/100
SO 81521-6	038.1500.060	200	10 x 1	12	14	21.0	26.5	10.5	19.0	13.5	4.5	3.540
SO 81521-8	038.1500.080	125	12 x 1	14	17	23.0	28.0	12.5	20.0	15.0	6.5	5.320
SO 81521-10	038.1500.100	80	14 x 1	17	19	25.5	31.0	14.5	21.0	15.5	8.5	7.710
SO 81521-12	038.1500.120	80	16 x 1	19	22	27.0	32.0	16.5	21.0	16.0	10.5	9.320
SO 81521-15	038.1500.150	25	20 x 1.5	24	27	30.5	36.5	20.5	24.0	18.0	13.0	16.080
SO 81521-18	038.1500.180	25	24 x 1.5	27	30	32.5	38.5	24.5	24.5	18.5	15.0	18.500

Weitere Reduktionen siehe SO 81821
Sechskantmutter siehe SO 80006

Autres réductions voir SO 81821
Ecrou à six pans voir SO 80006

Alternative reductions see SO 81821
Hexagon nut see SO 80006

Einstellnippel

Union orientable mâle

Adjustable male adaptor

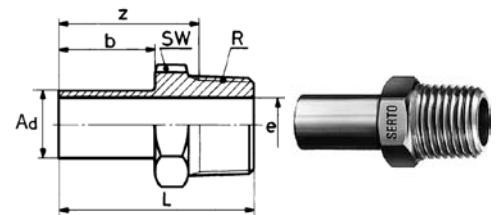

SO 81604

Type -Ad -R	Mat.-Nr.	bar	SW	L	b	z	e	kg/100
SO 81604-A15-1/2	038.1611.534	25	22	53.0	30.0	40.0	12.0	5.760

Anwendungsbeispiele:

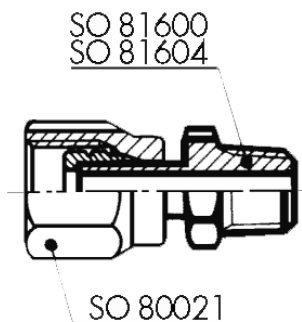

Dieser Einstellnippel ergibt im Zusammenhang mit unserem Armaturenanschluss SO 80021 einen einstellbaren Anschluss. Nur bei Typ SO 81604-d-R lässt sich die Anschlussmutter auf dem zyl. Schaft so weit zurückschieben, dass eine radiale Demontage möglich ist.

Exemples d'utilisation:



Cette union montée avec un écrou SO 80021 permet d'obtenir un raccord orientable mâle. La longueur libre plus importante des pièces SO 81604-d-R assure le recul de l'écrou afin de permettre le démontage radial.

Sample combinations:

In combination with our nut connection SO 80021 this adjustable male adaptor forms an adjustable male adaptor union. Radial dismantling is possible only with SO 81604-d-R as the nut can be fully withdrawn.

d=Rohrassen-ø
e= kleinste Bohrung
L= Mass in montiertem Zustand

d=ø extérieur du tube
e= ø-min. de passage
L=après montage

d=tube outside diameter
e=minimum bore
L=installed length

Einstellnippel
Union orientable mâle
Adjustable male adaptor

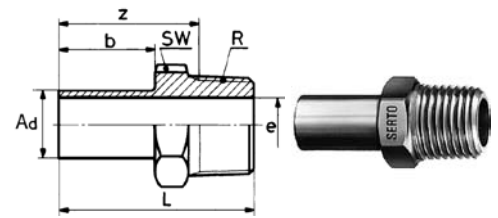

SO 81600

Type -Ad -R	Mat.-Nr.	bar	SW	L	b	z	e	kg/100
SO 81600-A6-1/8	038.1601.100	100	12	26.0	13.0	19.5	4.0	1.000
SO 81600-A6-1/4	038.1601.110	100	14	31.0	13.0	21.0	4.0	1.950
SO 81600-A8-1/8	038.1601.160	64	12	28.0	14.0	21.5	6.0	1.200
SO 81600-A8-1/4	038.1601.170	64	14	32.0	14.0	22.0	6.0	1.800
SO 81600-A10-1/4	038.1601.270	40	14	34.0	16.0	24.0	8.0	1.650
SO 81600-A10-3/8	038.1601.280	40	17	35.0	16.0	15.0	8.0	2.900
SO 81600-A10-1/2	038.1601.285	40	22	37.0	16.0	23.8	8.0	5.570
SO 81600-A12-3/8	038.1601.390	40	17	37.0	18.0	27.0	9.0	3.000
SO 81600-A12-1/2	038.1601.400	40	22	41.0	18.0	28.0	9.0	5.670

Anwendungsbeispiele:

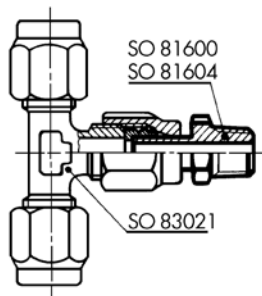

Kombiniert mit Winkel- oder T-Verschraubungen ergeben sich einstellbare Formteile.

Exemples d'utilisation:

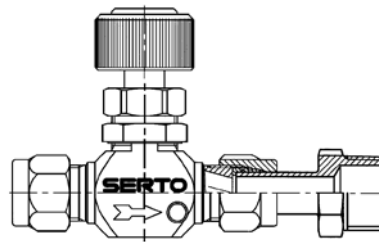

Cette union, combinée avec un coude ou un té, permet d'obtenir des raccords orientables.

Sample combinations:

Produces adjustable configurations in combination with elbow or tee unions.

Ad=Aussen-ø der Andrehung
 e= kleinste Bohrung
 L= Mass in montiertem Zustand

Ad=ø extérieur de la portée cylindrique
 e= ø-min. de passage
 L=après montage

Ad= outside diameter of cyl. Stub
 e=minimum bore
 L=installed length

Reduktionsverschraubung

Réduction

Reduction union

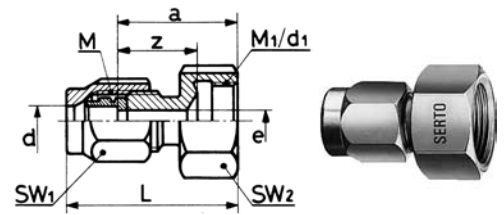

SO 81821

Type -d1 -d	Mat.-Nr.	bar	M	SW1	SW2	L	a	z	e	kg/100
* SO 81821-10-4	038.1800.167	80	10 x 1	12	17	27.5	20.0	13.0	4.0	2.580
SO 81821-10-6	038.1800.175	80	10 x 1	12	17	27.5	20.0	13.0	4.0	2.470
* SO 81821-12-6	038.1800.215	80	12 x 1	14	19	29.5	21.5	13.5	6.0	3.500
SO 81821-12-8	038.1800.225	80	12 x 1	14	19	29.5	21.5	13.5	6.0	3.340
* SO 81821-15-8	038.1800.400	40	14 x 1	17	24	33.5	23.5	15.5	8.0	5.920
SO 81821-15-10	038.1800.410	40	14 x 1	17	24	33.5	23.5	15.5	8.0	5.720
* SO 81821-18-10	038.1800.575	40	16 x 1	19	30	35.5	24.5	16.5	10.0	9.100
SO 81821-18-12	038.1800.580	40	16 x 1	19	30	35.5	24.5	16.5	10.0	8.820

Anwendungsbeispiele:

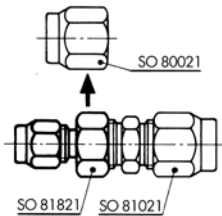

Die Reduktion SO 81821 kann an jedes SERTO-Formteil mit dem passenden Gewinde (d1/M1) aufgeschraubt werden. Durch diese Kombination ergeben sich weitere Rohrreduktionen.
 Dichtungsprinzip:
 Bei der Montage drückt sich die Dichtkante der Reduktion in das SERTO Formteil ein, dadurch entsteht eine einwandfreie metallische Dichtung. Wir empfehlen, das Gewinde mit einem geeigneten Flüssigklebstoff gegen unbeabsichtigtes Lösen zu sichern.

Exemples d'utilisation:

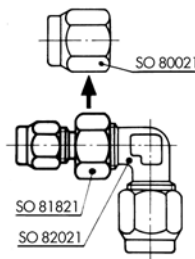

La réduction SO 81821 peut être montée sur toutes les pièces de forme SERTO avec le filetage (d1/M1) correspondant. De cette combinaison résulte d'autres réductions de tubes.
 Principe d'étanchéité:
 Lors du serrage, l'arête d'étanchéité de la réduction s'enfonce dans la pièce de forme SERTO et donne un joint métallique parfait. Nous recommandons de freiner le filetage avec une résine appropriée contre un desserrage intempestif.

Sample combinations:

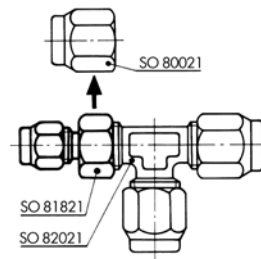

The reduction SO 81821 can be screwed onto every SERTO union body with the appropriate thread (d1/M1). From this combination result further tube reductions.
 Sealing principle:
 On being installed, the lip of the reduction presses into the SERTO union body, forming a sound metallic seal.
 We recommend to secure the thread with a suitable cement against unintended loosening.

d=Rohrassen-ø
 e= kleinste Bohrung
 L= Mass in montiertem Zustand
 *=mit reduziertem Klemmring

d=ø extérieur du tube
 e= ø-min. de passage
 L=après montage
 *=avec bague de serrage de réduction

d=tube outside diameter
 e=minimum bore
 L=installed length
 *= with reduction compression ferrule

Winkelverschraubung
Coude
Elbow union

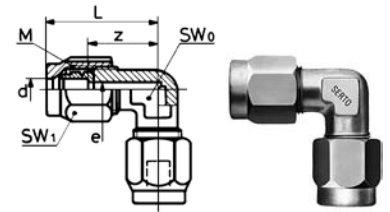

SO 82021

Type -d	Mat.-Nr.	bar	M	SW0	SW1	L	z	e	kg/100
SO 82021-6	038.2000.060	200	10 x 1	10	12	23.5	16.0	4.0	2.750
SO 82021-8	038.2000.080	125	12 x 1	10	14	26.0	18.0	6.0	3.680
SO 82021-10	038.2000.100	80	14 x 1	14	17	30.5	20.5	8.0	6.340
SO 82021-12	038.2000.120	80	16 x 1	17	19	32.5	21.5	10.0	7.920
SO 82021-15	038.2000.150	25	20 x 1.5	19	24	36.0	23.5	13.0	13.110
SO 82021-18	038.2000.180	25	24 x 1.5	22	27	39.5	25.5	15.0	18.020

Winkelverschraubung reduziert
Coude réduit
Elbow reduction union

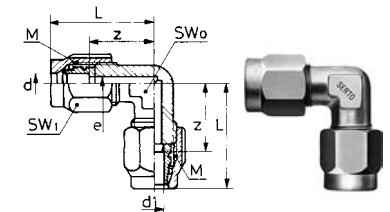

SO 82021 RED

Type -d-d1	Mat.-Nr.	bar	M	SW0	SW1	L	z	e	kg/100
* SO 82021-6-4	038.2004.110	100	10 x 1	10	12	23.5	16.0	4.0	2.860
* SO 82021-8-6	038.2004.140	125	12 x 1	10	14	26.0	18.0	6.0	3.740
* SO 82021-10-8	038.2004.190	125	14 x 1	14	17	30.5	20.0	8.0	6.540
* SO 82021-12-10	038.2004.240	80	16 x 1	17	19	32.5	21.5	10.0	9.000
* SO 82021-15-12	038.2004.420	40	20 x 1.5	19	24	36.0	23.5	13.0	13.650
* SO 82021-18-15	038.2004.610	25	24 x 1.5	22	27	39.5	25.5	15.0	18.720

Weitere Reduktionen siehe SO 81821

Autres réductions voir SO 81821

Alternative reductions see SO 81821

d=Rohraussen-ø
d1=Rohrinnendurchmesser
e= kleinste Bohrung
L= Mass in montiertem Zustand
*=mit reduziertem Klemmring

d=ø extérieur du tube
ø diam. Intérieur du tube
e= ø-min. de passage
L=après montage
*=avec bague de serrage de réduction

d=tube outside diameter
d1=tube inside diameter
e=minimum bore
L=installed length
*= with reduction compression ferrule

Winkel-Einschraubverschraubung

Coude mâle

Male adaptor elbow union

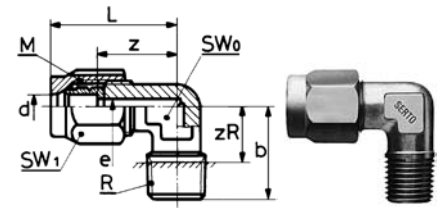

SO 82421

Type -d-R	Mat.-Nr.	bar	M	SW0	SW1	L	b	zR	z	e	kg/100
Für metrische Rohre	Pour tubes métriques		For metric tubes								
R=Rohrgewinde (kegelig)	R=Filetage-gaz BSP (conique)		R=BSP thread (tapered)								
* SO 82421-4-1/4	038.2401.065	100	10 x 1	10	12	23.5	22.5	13.0	18.0	4.0	1.800
SO 82421-6-1/8	038.2401.100	200	10 x 1	10	12	23.5	18.5	12.0	16.0	4.0	2.150
SO 82421-6-1/4	038.2401.110	200	10 x 1	10	12	23.5	22.5	13.0	18.0	4.0	2.880
SO 82421-8-1/8	038.2401.160	125	12 x 1	10	14	26.0	18.0	11.5	18.0	6.0	2.540
SO 82421-8-1/4	038.2401.170	125	12 x 1	10	14	26.0	22.5	13.0	18.0	6.0	3.090
* SO 82421-8-3/8	038.2401.180	125	14 x 1	14	17	30.5	25.0	15.0	20.5	8.0	5.310
SO 82421-10-1/4	038.2401.270	64	14 x 1	14	17	30.5	25.0	15.5	20.5	8.0	4.640
SO 82421-10-3/8	038.2401.280	80	14 x 1	14	17	30.5	25.0	15.0	20.5	8.0	5.110
SO 82421-10-1/2	038.2401.285	64	16 x 1	19	19	34.0	29.5	16.5	23.0	10.0	9.020
SO 82421-12-1/4	038.2401.380	80	16 x 1	17	19	32.5	26.0	16.5	21.5	8.0	8.480
SO 82421-12-3/8	038.2401.390	80	16 x 1	17	19	32.5	26.0	16.0	21.5	10.0	6.120
SO 82421-12-1/2	038.2401.400	80	16 x 1	19	19	34.0	29.5	16.5	23.0	10.0	8.710
SO 82421-15-1/2	038.2401.534	25	20 x 1.5	19	24	36.0	29.5	16.5	23.5	13.0	9.950
SO 82421-18-1/2	038.2401.646	25	24 x 1.5	22	27	39.5	31.5	18.5	25.5	15.0	12.520

Weitere Einschraubwinkel siehe Winkel mit Übergangsnippel SO 80040.

Autres coudes mâles voir coude avec adaptateur mâle SO 80040.

Alternative elbow union with male adaptor see SO 80040.

d=Rohrassen-ø
 e= kleinste Bohrung
 L= Mass in montiertem Zustand
 *=mit reduziertem Klemmring

d=ø extérieur du tube
 e= ø-min. de passage
 L=après montage
 *=avec bague de serrage de réduction

d=tube outside diameter
 L=installed length
 e=minimum bore
 *= with reduction compression ferrule

Einstellwinkel
Coude orientable
Adjustable elbow union

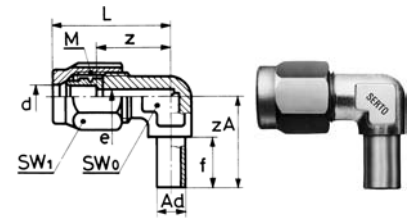

SO 82621

Type -d -Ad	Mat.-Nr.	bar	M	SW0	SW1	L	f	zA	z	e	kg/100
* SO 82621-4-A6	038.2600.045	100	10 x 1	10	12	23.5	11.0	17.5	16.0	4.0	1.980
SO 82621-6-A6	038.2600.060	200	10 x 1	10	12	23.5	11.0	17.5	16.0	4.0	1.870
* SO 82621-6-A8	038.2600.063	200	12 x 1	10	14	26.0	12.0	21.0	18.0	6.0	2.600
SO 82621-8-A8	038.2600.080	125	12 x 1	10	14	26.0	12.0	21.0	18.0	6.0	2.460
* SO 82621-8-A10	038.2600.083	125	14 x 1	14	17	30.5	14.0	24.0	20.5	8.0	4.180
SO 82621-10-A10	038.2600.100	80	14 x 1	14	17	30.5	14.0	24.0	20.5	8.0	3.990
* SO 82621-10-A12	038.2600.103	80	16 x 1	17	19	32.5	15.0	25.5	21.5	9.0	5.780
SO 82621-12-A12	038.2600.120	80	16 x 1	17	19	32.5	15.0	25.5	21.5	9.0	5.500
SO 82621-15-A15	038.2600.150	25	20 x 1.5	19	24	36.0	15.5	28.5	23.5	12.0	8.550
* SO 82621-15-A18	038.2600.156	25	24 x 1.5	22	27	39.5	18.0	33.5	25.5	15.0	13.280
SO 82621-18-A18	038.2600.180	25	24 x 1.5	22	27	39.5	18.0	33.5	25.5	15.0	12.530

Anwendungsbeispiele:

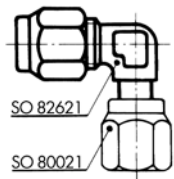

Der Einstellwinkel SO 82621 ergibt im Zusammenhang mit unserem Armaturenanschluss SO 80021 einen einstellbaren Winkelanschluss. Gegenüber dem Einschraubwinkel lässt sich diese Kombination einfacher einstellen, da Einschrauben und Ausrichten getrennt voneinander vorgenommen werden.

Exemples d'utilisation:

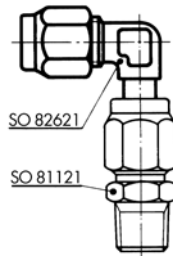

L'assemblage du SO 82621 et d'un écrou SO 80021 donne un coude orientable. Par rapport au coude mâle, cette combinaison permet un positionnement plus facile, car l'emboîtement et l'alignement s'ajustent séparément.

Sample combinations:

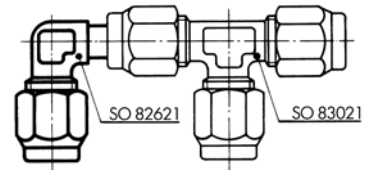

In combination with our nut connection SO 80021 this elbow forms an adjustable female adaptor elbow. In contrast to the simple male adaptor elbow union, this combination is easier to adjust, since screw-on and aligning are performed separately.

d=Rohrassen-ø
 Ad=Aussen-ø der Andrehung
 e= kleinste Bohrung
 L= Mass in montiertem Zustand
 *=mit reduziertem Klemmring

d=ø extérieur du tube
 Ad=ø extérieur de la portée cylindrique
 e= ø-min. de passage
 L=après montage
 *=avec bague de serrage de reduction

d=tube outside diameter
 Ad=outside diameter of cyl. Stub
 e=minimum bore
 L=installed length
 *=with reduction compression ferrule

Winkel-Schottverschraubung

Durchführungslänge max. 5mm

Union double pour passage de cloison

pour cloison max. 5 mm

Panel mount union

max. panel thickness 5 mm

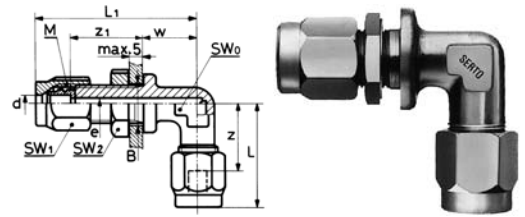

SO 82721

Type -d	Mat.-Nr.	bar	M	SW0	SW1	SW2	L	L1	w	z1	z	e	kg/100
★ SO 82721-4	038.2700.040	100	10 x 1	10	12	14	25.5	40.5	14.0	19.0	18.0	4.0	4.270
SO 82721-6	038.2700.060	200	10 x 1	10	12	14	25.5	40.5	14.0	19.0	18.0	4.0	4.160
SO 82721-8	038.2700.080	125	12 x 1	11	14	17	28.5	45.0	17.0	20.0	20.5	6.0	6.480
SO 82721-10	038.2700.100	80	14 x 1	14	17	19	33.5	49.0	18.0	21.0	23.5	8.0	9.560
SO 82721-12	038.2700.120	80	16 x 1	14	19	19	34.5	50.0	18.0	21.0	23.5	9.0	10.640
SO 82721-15	038.2700.150	25	20 x 1.5	19	24	27	38.0	56.5	20.0	24.0	25.5	12.5	18.300

Weitere Reduktionen siehe SO 81821
Sechskantmutter siehe SO 80006

Autres réductions voir SO 81821
Ecrou à six pans voir SO 80006

Alternative reductions see SO 81821
Hexagon nut see SO 80006

T-Verschraubung

Té

Tee union

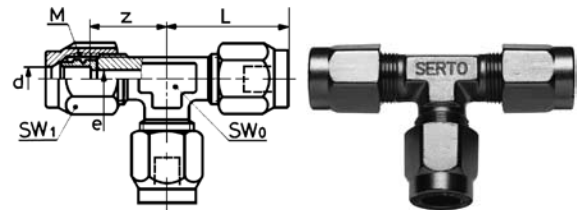

SO 83021

Type -d	Mat.-Nr.	bar	M	SW0	SW1	L	z	e	kg/100
SO 83021-6	038.3000.060	200	10 x 1	10	12	23.5	16.0	4.0	4.240
SO 83021-8	038.3000.080	125	12 x 1	10	14	26.0	18.0	6.0	5.590
SO 83021-10	038.3000.100	80	14 x 1	14	17	30.5	20.5	8.0	8.840
SO 83021-12	038.3000.120	80	16 x 1	17	19	32.5	21.5	10.0	11.320
SO 83021-15	038.3000.150	25	20 x 1.5	19	24	36.0	23.5	13.0	187.500
SO 83021-18	038.3000.180	25	24 x 1.5	22	27	39.5	25.5	15.0	25.600

d=Rohraussen-ø
d1=Rohrinnendurchmesser
e= kleinste Bohrung
L= Mass in montiertem Zustand
*=mit reduziertem Klemmring

d=ø extérieur du tube
ø diam. Intérieur du tube
e= ø-min. de passage
L=après montage
*=avec bague de serrage de reduction

d=tube outside diameter
d1=tube inside diameter
e=minimum bore
L=installed length
*=with reduction compression ferrule

T-Verschraubung mit Einstellzapfen

Té orientable

Adjustable tee union

SO 83621 T

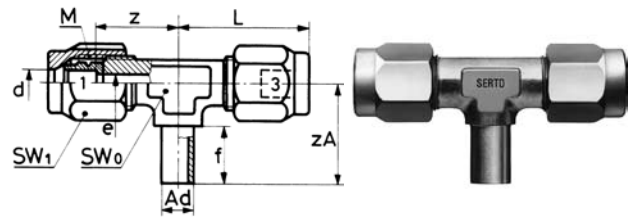

Type -d1 -Ad -d3	Mat.-Nr.	bar	M	SW0	SW1	L	f	zA	z	e	kg/100
* SO 83621-4-A6-4	038.3600.045	200	10 x 1	10	12	23.5	11.0	17.5	16.0	4.0	3.540
SO 83621-6-A6-6	038.3600.060	200	10 x 1	10	12	23.5	11.0	17.5	16.0	4.0	3.160
SO 83621-8-A8-8	038.3600.080	125	12 x 1	10	14	26.0	12.0	21.0	18.0	6.0	4.230
SO 83621-10-A10-10	038.3600.100	80	14 x 1	14	17	30.5	14.0	24.0	20.5	7.5	6.970

Anwendungsbeispiele:

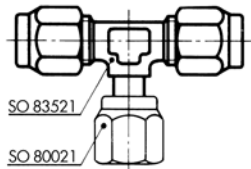

Exemples d'utilisation:

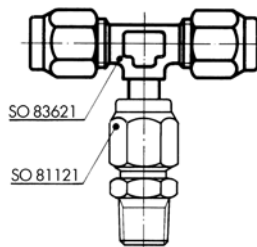

Sample combinations:

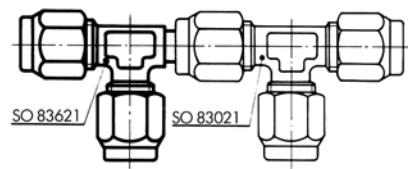

Die T-Verschraubung mit Einstellzapfen SO 83621 ergibt im Zusammenhang mit unserem Armaturenanschluss SO 80021 eine einstellbare T-Kombination. Kombinationsbeispiele: Gegenüber dem Einschraub-T lässt sich diese Kombination einfacher einstellen, da Einschrauben und Ausschrauben getrennt voneinander vorgenommen werden.

L'assemblage du SO 83621 et d'un écrou SO 80021 donne un Té orientable. Exemples d'utilisation: Par rapport à un Té cette combinaison permet un positionnement plus facile. L'emboîtement et l'alignement se font séparément.

In combination with our nut connection SO 80021 the adjustable Tee union SO 83621 forms an adjustable female adaptor Tee union. Sample combinations: In contrast to the simple male adaptor Tee union, this combination is easier to adjust, since screw-on and aligning are performed separately.

L-Verschraubung

mit Einstellzapfen

L orientable

Adjustable L union

SO 83621 L

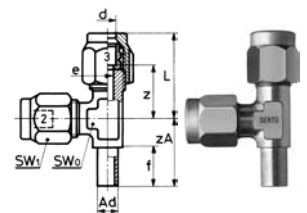

Type -Ad -d2 -d3	Mat.-Nr.	bar	M	SW0	SW1	L	f	zA	z	e	kg/100
* SO 83621-A6-4-4	038.3610.045	200	10 x 1	10	12	23.5	11.0	17.5	16.0	4.0	3.600
SO 83621-A6-6-6	038.3610.060	200	10 x 1	10	12	23.5	11.0	17.5	16.0	4.0	3.220
SO 83621-A8-8-8	038.3610.080	125	12 x 1	10	14	26.0	12.0	21.0	18.0	6.0	4.260
SO 83621-A10-10-10	038.3610.100	80	14 x 1	14	17	30.5	14.0	24.0	20.5	7.5	7.000

d=Rohrassen-ø
Ad=Aussen-ø der Andrehung
e=kleinste Bohrung
L=Mass in montiertem Zustand
*=mit reduziertem Klemmring

d=ø extérieur du tube
Ad=ø extérieur de la portée cylindrique
e=ø-min. de passage
L=après montage
*=avec bague de serrage de réduction

d=tube outside diameter
Ad=outside diameter of cyl. Stub
e=minimum bore
L=installed length
*=with reduction compression ferrule

Einschraub-T

Té mâle

Male adaptor Tee union

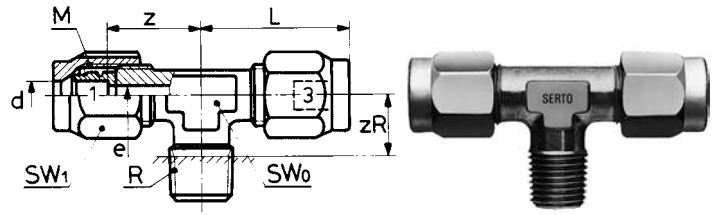

SO 83721 T

Type -d-R-d	Mat.-Nr.	bar	M	SW0	SW1	L	zR	z	e	kg/100
R=Rohrgewinde (kegelig)	R=Filetage-gaz BSP (conique)									
SO 83721-4-1/8-4	038.3701.040	125	8 x 1	7	10	22.0	10.5	16.0	3.0	2.350
* SO 83721-4-1/4-4	038.3701.045	125	10 x 1	10	12	23.5	13.0	16.0	4.0	4.110
SO 83721-5-1/8-5	038.3701.070	125	8 x 1	7	10	22.5	10.5	16.0	3.0	2.330
* SO 83721-5-1/4-5	038.3701.075	125	10 x 1	10	12	23.5	13.0	16.0	4.0	4.060
SO 83721-6-1/8-6	038.3701.100	200	10 x 1	10	12	23.5	11.0	16.0	4.0	3.240
SO 83721-6-1/4-6	038.3701.110	200	10 x 1	10	12	23.5	13.0	18.0	4.0	4.000
SO 83721 8-1/4-8	038.3701.170	125	12 x 1	10	14	26.0	13.0	18.0	6.0	4.730
SO 83721-10-1/4-10	038.3701.270	80	14 x 1	14	17	30.5	15.5	20.5	8.0	7.900

d=Rohrassen-ø
 e= kleinste Bohrung
 L= Mass in montiertem Zustand
 *=mit reduziertem Klemmring

d=ø extérieur du tube
 e= ø-min. de passage
 L=après montage
 *=avec bague de serrage de réduction

d=tube outside diameter
 e=minimum bore
 L=installed length
 *=with reduction compression ferrule

Reduziermuffe

Réduction femelle-femelle

Female reduction socket

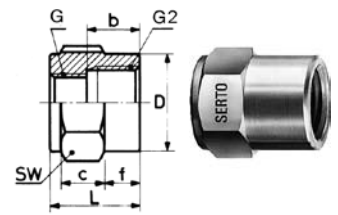

SO 80031

Type -G -G2	Mat.-Nr.	SW	L	b	c	D	f	kg/100
G=Rohrgewinde (zylindrisch)	G=Filetage-gaz BSP (cylindrique)	G=BSP thread (straight)						
G2=Rohrgewinde (zylindrisch)	G2=Filetage-gaz BSP (cylindrique)	G2=BSP thread (straight)						
SO 80031-1/8-1/8	036.0311.042	14	16.0	8.0	8.0	13.8	6.0	1.240
SO 80031-1/8-1/4	036.0311.044	17	19.0	11.0	9.0	16.8	8.0	2.170
SO 80031-1/4-1/4	036.0311.104	17	18.0	9.0	9.0	16.8	7.0	1.710
SO 80031-1/4-3/8	036.0311.106	22	21.0	12.0	10.0	21.8	9.0	4.060
SO 80031-1/4-1/2	036.0311.108	27	23.0	14.0	12.0	26.8	9.0	6.900
SO 80031-3/8-3/8	036.0311.166	22	19.0	9.5	10.0	21.8	7.0	3.090
SO 80031-3/8-1/2	036.0311.168	27	23.5	14.0	12.0	27.0	9.5	6.520
SO 80031-1/2-1/2	036.0311.228	27	23.0	11.5	12.0	26.8	9.0	5.450
SO 80031-3/4-1/2	036.0311.288	32	28.5	11.5	13.0	31.8	13.5	9.870

Reduziernippel

Einschraubgewinde kegelig

Réduction femelle-mâle

Filetage conique

Male reduction nipple

Tapered adaptor thread

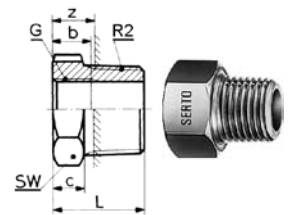

SO 80041

Type -G -R2	Mat.-Nr.	SW	L	b	c	z	kg/100
G=Rohrgewinde (zylindrisch)	G=Filetage-gaz BSP (cylindrique)	G=BSP thread (straight)					
R2=Rohrgewinde (kegelig)	R2=Filetage-gaz BSP (conique)	R2=BSP thread (tapered)					
SO 80041-1/8-1/8	036.0411.042	14	21.0	8.0	13.0	14.5	2.100
SO 80041-1/8-1/4	036.0411.044	14	17.5	8.0	5.5	8.0	1.060
SO 80041-1/8-1/2	036.0411.048	22	23.0	8.0	7.0	10.0	3.970
SO 80041-1/4-1/8	036.0411.102	17	22.0	9.0	8.5	15.5	1.630
SO 80041-1/4-3/8	036.0411.106	17	20.0	9.0	7.5	10.0	1.690
SO 80041-1/4-1/2	036.0411.108	22	23.0	9.0	7.0	10.0	3.590
SO 80041-3/8-1/2	036.0411.168	22	23.0	9.5	7.0	10.0	2.740
SO 80041-1/2-3/4	036.0411.232	27	27.5	11.5	11.0	13.0	5.133

Bei der Bestellung bitte G und R2 nicht verwechseln.

Lors de la commande ne pas confondre G et R2.

Please do not confuse G and R2 when ordering.

Reduziernippel NPT-R

Einschraubgewinde kegelig

Réduction femelle-mâle NPT-R

Filetage conique

Male reduction nipple NPT-R

Tapered adaptor thread

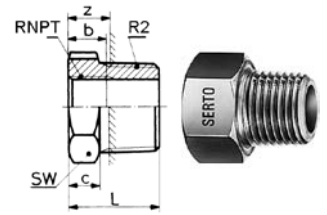

SO 80041 NPT R

Type -RNPT -R2	Mat.-Nr.	SW	L	b	c	z	kg/100
RNPT=NPT Gewinde		RNPT=Filetage NPT				RNPT=NPT thread	
R2=Rohrgewinde (kegelig)		R2=Filetage-gaz BSP (conique)				R2=BSP thread (tapered)	
SO 80041-1/8 NPT-1/8	036.0414.042	14	21.0	6.5	13.0	14.5	1.470
SO 80041-1/8 NPT-1/4	036.0414.044	14	18.0	6.6	6.0	8.0	1.130
SO 80041-1/4 NPT-1/4	036.0414.104	17	29.5	9.5	17.5	20.0	2.740
SO 80041-1/4 NPT-3/8	036.0414.106	17	19.0	9.5	7.0	9.0	1.650
SO 80041-1/2 NPT-1/2	036.0414.228	27	38.0	12.5	22.0	25.0	8.310

Verschlusschraube

Bouchon d'obturation

Screw plug

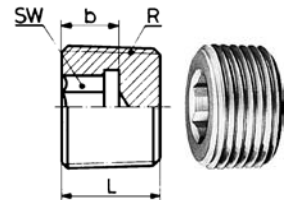

SO 80371

Type -R	Mat.-Nr.	SW	L	b	kg/100
R=Rohrgewinde (kegelig)		R=Filetage-gaz BSP (conique)			R=BSP thread (tapered)
SO 80371-1/8	036.0711.020	5	8.0	5.5	0.340
SO 80371-1/4	036.0711.040	7	10.0	7.5	0.750
SO 80371-3/8	036.0711.060	8	10.0	6.5	1.320
SO 80371-1/2	036.0711.080	10	10.0	6.5	1.940

Einschraubtülle

Douille cannelée à visser

Male adaptor hose nozzle

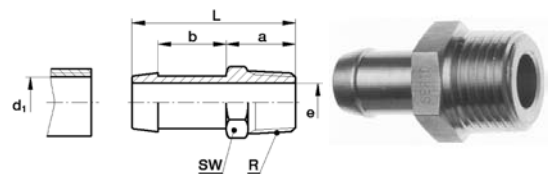

SO 80511

Type -d1 -R	Mat.-Nr.	SW	L	b	d1	e	kg/100
SO 80511-6-1/8	036.0511.100	10	29.0	12.0	6.00	4.0	0.730
SO 80511-6-1/4	036.0511.110	14	34.5	12.0	6.00	4.0	1.920
SO 80511-8-1/4	036.0511.170	14	34.5	12.0	8.00	6.0	1.690
SO 80511-10-1/4	036.0511.270	14	36.5	14.0	10.00	7.0	1.640
SO 80511-13-3/8	036.0511.450	17	39.0	15.0	13.00	10.0	2.910