

**Stahl**

**Verschraubungen**





















**Acier**

**Raccords**

**Steel**

**Unions**



	Seite/Page/Page		Seite/Page/Page		Seite/Page/Page
Montagestutzen Pièce de montage Pre-assembly stud	<b>6.3</b>  <b>SO 6000</b>	Einstellbare T-Verschraubung Té orientable Adjustable tee union	<b>6.13</b>  <b>SO 6135</b>	Anschweißverschraubung Union simple avec embout à souder Weld-on union	<b>6.24</b>  <b>SO 6336</b>
Abschlusszapfen Bouchon d'arrêt Plug	<b>6.4</b>  <b>SO 40002</b>	Gerade Verschraubung Union double Straight union	<b>6.14</b>  <b>SO 6240</b>	Einstellbare Kupplung Raccord orientable Adjustable coupling	<b>6.25-6.26</b>  <b>SO 6345</b>
Winkelverschraubung Coude Elbow union	<b>6.7</b>  <b>SO 6090</b>	Reduziernippel Réduction femelle-mâle Male reduction nipple	<b>6.15</b>  <b>SO 6241</b>	Klemmring Bague de serrage Compression ferrule	<b>6.28</b>  <b>SO 6372</b>
Einschraubwinkel Coude mâle Male adaptor elbow union	<b>6.8</b>  <b>SO 6092</b>	Reduzier-Verschraubung Union de réduction Reduction union	<b>6.16</b>  <b>SO 6248</b>	Anschlussmutter Ecroû Union nut	<b>6.29</b>  <b>SO 6374</b>
Winkel-Schottverschraubung Coude pour passage de cloison Panel mount elbow union	<b>6.9</b>  <b>SO 6093</b>	Gerade Einschraubverschraubung Union mâle Male adaptor union	<b>6.18-6.19</b>  <b>SO 6331</b>		
Einstellbare Winkelverschraubung Coude orientable Adjustable elbow union	<b>6.10</b>  <b>SO 6095</b>	Verschraubung mit Anschlussmuffe Union femelle Female adaptor union	<b>6.20</b>  <b>SO 6332</b>		
Drosselfreie Schwenkverschraubung Coude banjo à passage non réduit Non-throttling single banjo	<b>6.11</b>  <b>SO 6096</b>	Gerade Schottverschraubung Union double pour passage de cloison Panel mount union	<b>6.21</b>  <b>SO 6333</b>		
T-Verschraubung Té Tee union	<b>6.12</b>  <b>SO 6130</b>	Einstellbarer Anschluss Raccordement orientable Adjustable connection	<b>6.22-6.23</b>  <b>SO 6335</b>		

**Sonderausführungen:  
Exécution en option:  
Optional Services:**

-  Spezialbehandlung für Einsatz mit Sauerstoff  
Traitement spécial pour utilisation sous oxygène  
Special treatment for use with oxygen
-  Spezialbehandlung - silikonefrei  
Traitement spécial - sans silicone  
Special treatment - silicone free
-  Spezialreinigung - entfettet  
Traitement spécial - sans silicone  
Special treatment - degreased
-  Vorbeschichtete Gewinde mit Loctite 5061  
Filetages pré enduits avec Loctite 5061  
Pre-coated threads with Loctite 5061
-  Vorbeschichtete Gewinde PTFE-Band umwickelt  
Filetages pré enduits avec ruban en PTFE  
Pre-coated threads with PTFE-tape

Stahl	Acier	Steel
-------	-------	-------

**Eigenschaften, Besonderheiten**

- einfache, schnelle Montage
- kompakte Baumasse
- grosse Sortimentsvielfalt
- viele Kombinationsmöglichkeiten
- hohe Betriebsdrücke

**Funktionsprinzip**

siehe Anhang

**Anwendung**

Zur Verbindung von Präzisionsrohren aus Stahl. Besonders für hohe Betriebsdrücke, z.B. in der Hydraulik.

**Werkstoff**

Stahl nach DIN 3859  
Blauverzinkt mit Dickschichtpassivierung\*

**Nenndruck PN**

siehe Produktetabellen (4-fache Sicherheit).  
Dynamische Belastungen auf Anfrage.

**Temperaturbereich**

-40°C bis +200°C.

**Anzuschliessende Rohre**

Nahtlose Präzisionsrohre nach EN 10305-1 aus St 35.4, normalblankgeglüht (NBK), blank oder rostschutzgebondert. Kunststoffrohre, Aussendurchmesser innerhalb ± 0,1 mm. Siehe auch Kapitel Rohre und Schläuche sowie Tabelle Mindestwandungen im Anhang.

\* entspricht Richtlinien 2002/95/EG und 2000/53/EG

**Généralités**

- Montage facile et rapide
- compactes dimensions
- programme étendu
- multiples possibilités de combinaisons
- pressions de service élevées

**Principe de fonctionnement**

voir annexe

**Application**

Pour assembler des tubes en acier. Particulièrement pour des pressions de service élevées. P. ex. dans le domaine de l'hydraulique.

**Matériau**

Acier selon DIN 3859  
Zinqué bleu avec passivation de couche épaisse\*

**Pression nominale PN**

voir tableaux des produits (facteur de sécurité 4). Sollicitations dynamique sur demande.

**Plage de température admissible**

-40°C à +200°C.

**Tubes à utiliser**

Utiliser, avec les raccords à bague de serrage SERTO en acier, des tubes de précision sans soudure selon EN 10305-1 en Ac 35.4, recuit blanc, exécution polie ou bondérisée. Tubes en matières plastiques, diamètre extérieur dans une tolérance de ± 0,1 mm. Voir chapitre «tubes, tuyaux» et le tableau épaisseur de paroi minimale en annexe.

\* selon directive 2002/95/CE et 2000/53/CE

**Characteristics, specialities**

- easy and fast to install
- compact size
- wide selection of compatible components
- extensive range of combinations
- high operating pressures

**Operating principle**

see appendix

**Application**

To connect precision steel tubes, in particular for high operating pressures. For example in the hydraulic field.

**Material**

Steel of DIN 3859  
Blue galvanization with thick film passivation\*

**Nominal pressure PN**

see product table (safety factor 4). Dynamic loads on demand.

**Temperature range**

-40°C to +200°C.

**Tubes to use**

Seamless precision steel tubing conforming to EN 10305-1 of St 35.4, normalized bright annealed (NBK) with bright or rust preventative bonded finish. Plastic tubing with diameters within ± 0,1 mm. See also chapter «tubes, hoses» and table «minimum wall for tube outside diameter» in the appendix.

\* according to directives 2002/95/EC and 2000/53 EC

**Druckauswertungsgrad in % des PN**

**Coefficient de pression de service admissible en % de PN**

**Pressure coefficient % of PN**

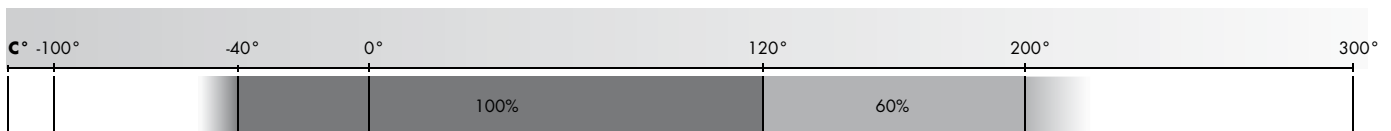

# Montagestutzen

## Pièce de montage

### Pre-assembly stud

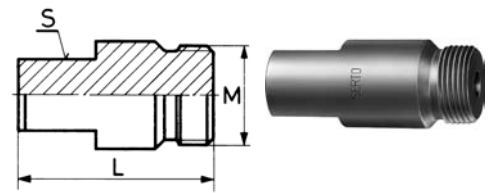

### SO 6000

Type-d	Mat.-Nr.	M	L	S	kg/100
Für metrische Rohre	Pour tubes métriques			For metric tubes	
SO 6000-6	218.6000.060	12 x 1.5	40.0	11.0	4.300
SO 6000-8	218.6000.080	14 x 1.5	40.0	14.0	6.960
SO 6000-10	218.6000.100	16 x 1.5	40.0	14.0	9.700
SO 6000-12	218.6000.120	18 x 1.5	40.0	17.0	12.400
SO 6000-14	218.6000.140	22 x 1.5	40.0	19.0	20.000
SO 6000-15	218.6000.150	22 x 1.5	40.0	19.0	20.000
SO 6000-16	218.6000.160	24 x 1.5	40.0	19.0	21.300
SO 6000-18	218.6000.180	26 x 1.5	40.0	22.0	28.400
SO 6000-20	218.6000.200	26 x 1.5	40.0	22.0	28.400
SO 6000-22	218.6000.220	30 x 2	58.0	24.0	36.280
SO 6000-25	218.6000.250	33 x 2	58.0	24.0	38.750
SO 6000-28	218.6000.280	36 x 2	58.0	27.0	52.900
SO 6000-30	218.6000.300	39 x 2	58.0	30.0	58.000

Der Montagestutzen wird zur serienmässigen Vormontage von SERTO-Verschraubungen aus Stahl verwendet.

**Anwendung:**  
Montagestutzen in Schraubstock einspannen. Klemmring SO 6372 und Anschlussmutter SO 6374 montieren. Rohr in Armaturenanschluss stecken. Mit Gabelschlüssel Anschlussmutter ca. 1 1/2 Umdrehungen anziehen. Montageanleitung beachten.

Werkstoff: CrNi-St. gehärtet.

Für automatisierte Vormontage siehe Apparate SERTOtool/SERTOmatic im Kapitel Werkzeuge und Zubehör.

La pièce de montage s'utilise pour le prémontage standard de raccords SERTO en acier.

**Procédé de montage:**  
Serrer la pièce de montage dans l'étau. Monter la bague de serrage SO 6372 et l'écrou SO 6374. Enfiler le tube dans l'écrou de raccordement. Au moyen d'une clef à fourche, serrer l'écrou d'environ 1 1/2 tours. Observer l'instruction de montage.

Matériau: Acier CrNi trempé.

Pour prémontage automatique voir les appareils SERTOtool/SERTOmatic au chapitre accessoires et outillage.

The pre-assembly stud is employed for the batch prefitting of SERTO unions of steel.

**Directions:**  
Clamp pre-assembly stud in vise. Assemble the compression ferrule SO 6372 and the union nut SO 6374. Push tube into nut connection. Tighten the union nut about 1 1/2 turns with open spanner. Refer further to assembly instructions.

Material: CrNi steel, hardened.

For automated pre-assembly see the machines SERTOtool/SERTOmatic at chapter accessories and tools.

# Abschlusszapfen

## Bouchon d'arrêt

### Plug

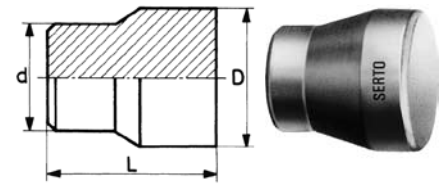

SO 40002

## SO 40002

Type -d	Mat.-Nr.	L	D	kg/100
Für metrische Rohre	Pour tubes métriques		For metric tubes	
SO 40002-4	016.0020.040	8.0	6.8	0.150
SO 40002-5	016.0020.050	8.5	6.8	0.190
SO 40002-6	016.0020.060	10.0	8.4	0.310
SO 40002-8	016.0020.080	10.5	10.5	0.570
SO 40002-10	016.0020.100	13.0	12.7	0.960
SO 40002-12	016.0020.120	14.0	14.8	1.470
SO 40002-14	016.0020.140	15.0	17.5	2.230
SO 40002-15	016.0020.150	15.0	18.0	2.370
SO 40002-18	016.0020.180	16.8	22.0	4.000
SO 40002-22	016.0020.220	19.0	26.0	6.300
SO 40002-28	016.0020.280	22.5	32.5	11.900
SO 40002-35	016.0020.350	25.2	39.5	20.000

### Anwendungsbeispiele:

### Exemples d'utilisation:

### Sample combinations:

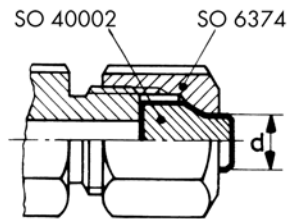

Werkstoff: Messing

Matériau: Laiton

Material: Brass

Der Abschlusszapfen lässt sich in jede Verschraubung anstelle eines Klemmringes gleicher Größe d einsetzen.

Le bouchon d'arrêt peut remplacer la bague de serrage de même dimension d dans chaque raccord.

The plug can be fitted into any union in place of a compression ferrule of same diameter d.

Anschlussmutter mit 1/4 Drehung anziehen.

Serrer l'écrou avec 1/4 tour.

Tighten the union nut with 1/4 turn.

## Stützhülse

zur Rohrverstärkung

## Douille d'appui

pour renforcer les tubes

## Stiffener sleeve

to reinforce the tubes

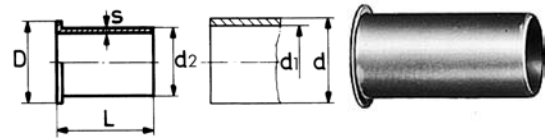

### SO 40003

Type - d - d1	Mat.-Nr.	L	D	s	kg/100
Für metrische Rohre	Pour tubes métriques	For metric tubes			
SO 40003-3-2	016.0030.020	6.0	2.8	0.20	0.006
SO 40003-3-2,4	016.0030.024	6.0	2.8	0.20	0.007
SO 40003-4-2	016.0030.030	8.0	3.8	0.20	0.008
SO 40003-4-2,5	016.0030.035	8.0	3.8	0.20	0.010
SO 40003-4-3	016.0030.040	8.0	3.8	0.20	0.010
SO 40003-5-3	016.0030.060	8.0	4.5	0.20	0.015
SO 40003-5-3,5	016.0030.075	8.0	4.5	0.20	0.020
SO 40003-6-3	016.0030.100	10.0	5.2	0.20	0.015
SO 40003-6-4	016.0030.110	10.0	5.5	0.20	0.025
SO 40003-6-4,4	016.0030.113	10.0	5.5	0.20	0.025
SO 40003-6-4,65	016.0030.116	10.0	5.5	0.20	0.025
SO 40003-6-4,7 D	016.0030.118	10.0	5.5	0.40	0.046
SO 40003-8-5	016.0030.136	12.0	7.5	0.25	0.040
SO 40003-8-5,5	016.0030.138	12.0	7.5	0.25	0.045
SO 40003-8-6	016.0030.140	12.0	7.5	0.25	0.045
SO 40003-8-6,4	016.0030.144	12.0	7.5	0.25	0.050
SO 40003-10-7	016.0030.180	16.0	9.5	0.30	0.080
SO 40003-10-7,5	016.0030.185	16.0	9.5	0.30	0.090
SO 40003-10-8	016.0030.190	16.0	9.5	0.30	0.100
SO 40003-10-8 D	016.0030.189	16.0	9.5	0.60	0.190
SO 40003-10-8,4	016.0030.192	16.0	9.5	0.30	0.095
SO 40003-10-8,6	016.0030.193	16.0	9.5	0.30	0.095
SO 40003-12-9	016.0030.230	20.0	11.5	0.40	0.190
SO 40003-12-9,5	016.0030.235	20.0	11.5	0.40	0.195
SO 40003-12-10	016.0030.240	20.0	11.5	0.40	0.195
SO 40003-12-10,4	016.0030.254	20.0	11.5	0.40	0.195
SO 40003-12-11 D	016.0030.257	20.0	12.0	1.00	0.500
SO 40003-13-11	016.0030.280	20.0	12.5	0.50	0.330
SO 40003-13-11 D	016.0030.279	20.0	12.5	1.00	0.530
SO 40003-14-11	016.0030.330	24.0	13.5	0.50	0.350
SO 40003-14-11,5	016.0030.335	24.0	13.5	0.50	0.350
SO 40003-14-12	016.0030.340	24.0	13.5	0.50	0.370
SO 40003-15-12,5	016.0030.425	24.0	14.5	0.50	0.390
SO 40003-15-13	016.0030.430	24.0	14.5	0.50	0.390

Fortsetzung nächste Seite

Suite à la prochaine page

Continued on next page

## Stützhülse

zur Rohrverstärkung

## Douille d'appui

pour renforcer les tubes

## Stiffener sleeve

to reinforce the tubes

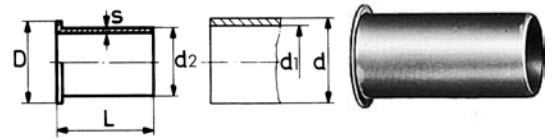

### SO 40003

Type - d - d1	Mat.-Nr.	L	D	s	kg/100
Für metrische Rohre	Pour tubes métriques				For metric tubes
SO 40003-16-13,5	016.0030.495	26.0	15.5	0.50	0.430
SO 40003-16-14	016.0030.500	26.0	15.5	0.50	0.470
SO 40003-16-14 D	016.0030.499	26.0	15.5	0.10	0.900
SO 40003-17-15	016.0030.540	26.0	16.5	0.60	0.590
SO 40003-18-15	016.0030.610	26.0	16.5	0.60	0.590
SO 40003-18-15,6	016.0030.616	26.0	17.5	0.60	0.610
SO 40003-18-16	016.0030.620	26.0	17.5	0.60	0.630
SO 40003-19-17	016.0030.640	28.0	18.5	0.60	0.820
SO 40003-19-17 D	016.0030.642	28.0	19.0	1.00	1.140
SO 40003-20-17	016.0030.690	28.0	19.5	0.60	0.800
SO 40003-20-18	016.0030.700	28.0	19.5	0.60	0.830
SO 40003-22-19	016.0030.760	30.0	21.5	0.60	0.850
SO 40003-22-19,6	016.0030.771	30.0	21.5	0.60	0.940
SO 40003-22-20	016.0030.775	30.0	21.5	0.60	0.980
SO 40003-28-25	016.0030.870	36.0	27.5	0.80	1.500
SO 40003-28-25,6	016.0030.876	36.0	27.5	0.80	1.600
SO 40003-35-32	016.0030.890	41.0	34.0	0.85	2.500

Werkstoff: Messing

Verstärken:

Dünnwandige und weiche Rohre sowie alle Kunststoffrohre sind vor dem Einführen in die SERTO Verschraubung mit Stützhülsen zu verstärken.

Genauere Angaben über das Verstärken sind den einzelnen Verschraubungsreihen im Anhang zu entnehmen. Zum Entgraten und Kalibrieren der Rohre eignen sich besonders unsere Hilfswerkzeuge.

Matériau: Laiton

Renforcement:

Les tubes présentant une paroi mince, les tubes en matière souple ainsi que les tubes en matière plastique doivent être renforcés à l'aide de douilles d'appui avant d'être introduits dans les raccords SERTO.

Des indications plus précises concernant le renforcement sont données pour chaque série de raccord dans l'annexe. L'ébarbage et le calibrage du tube sont facilités par l'emploi de notre outil spécial.

Material: Brass

Reinforcement:

Thin walled and soft tubes and all plastic tubes, are to be reinforced with stiffener sleeves before introducing them into the SERTO union.

Exact details concerning stiffening are to be found in the sections on the relevant model series in the appendix. Our tools are especially useful for deburring and calibrating tubing.

# Winkelverschraubung

## Coude

## Elbow union

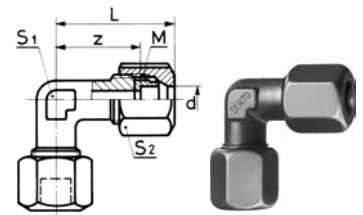

### SO 6090

Type -d	Mat.-Nr.	bar	M	L	S1	S2	z	kg/100
Für metrische Rohre	Pour tubes métriques				For metric tubes			
SO 6090-6	218.2000.060	400	12 x 1.5	29.0	12	14	20.0	4.000
SO 6090-8	218.2000.080	300	14 x 1.5	31.0	12	17	22.0	6.200
SO 6090-10	218.2000.100	250	16 x 1.5	34.0	14	19	23.0	9.000
SO 6090-12	218.2000.120	250	18 x 1.5	38.0	17	22	25.0	12.700
SO 6090-14	218.2000.140	250	22 x 1.5	42.0	19	27	29.0	21.500
SO 6090-15	218.2000.150	200	22 x 1.5	42.0	19	27	29.0	21.500
SO 6090-16	218.2000.160	200	24 x 1.5	46.0	22	30	31.0	28.200
SO 6090-18	218.2000.180	200	26 x 1.5	48.0	24	32	32.0	32.400
SO 6090-20	218.2000.200	200	26 x 1.5	52.0	24	32	35.0	33.800
SO 6090-22	218.2000.220	160	30 x 2	52.0	27	36	37.0	42.400
SO 6090-25	218.2000.250	160	33 x 2	57.0	30	41	40.0	61.500
SO 6090-28	218.2000.280	160	36 x 2	56.0	36	41	40.0	58.800

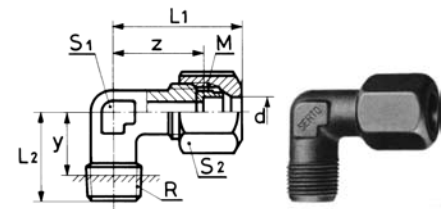

**Einschraubwinkel**
**Coude mâle**
**Male adaptor elbow union**

**SO 6092**

Type -d-R	Mat.-Nr.	bar	M	L1	L2	S1	S2	y	z	kg/100
Für metrische Rohre	Pour tubes métriques			For metric tubes						
SO 6092-6-1/8	218.2401.100	400	12 x 1.5	29.0	20.0	12	14	15.0	20.0	3.100
SO 6092-6-1/4	218.2401.110	400	12 x 1.5	31.0	26.0	12	14	18.0	22.0	4.000
SO 6092-8-1/8	218.2401.160	300	14 x 1.5	31.0	26.0	12	17	21.0	22.0	4.300
SO 6092-8-1/4	218.2401.170	300	14 x 1.5	31.0	26.0	12	17	18.0	22.0	4.600
SO 6092-10-1/4	218.2401.270	250	16 x 1.5	34.0	27.0	14	19	19.0	23.0	6.400
SO 6092-10-3/8	218.2401.280	250	16 x 1.5	36.0	28.0	17	19	20.0	25.0	8.300
SO 6092-12-3/8	218.2401.390	250	18 x 1.5	38.0	28.0	17	22	20.0	25.0	8.600
SO 6092-14-3/8	218.2401.502	250	22 x 1.5	42.0	32.0	19	27	24.0	29.0	14.500
SO 6092-14-1/2	218.2401.504	250	22 x 1.5	42.0	32.0	19	27	22.0	29.0	15.600
SO 6092-15-3/8	218.2401.532	200	22 x 1.5	42.0	32.0	19	27	24.0	29.0	14.500
SO 6092-15-1/2	218.2401.534	200	22 x 1.5	42.0	32.0	19	27	22.0	29.0	15.600
SO 6092-16-1/2	218.2401.566	200	24 x 1.5	46.0	35.0	22	30	25.0	31.0	19.600
SO 6092-18-1/2	218.2401.646	200	26 x 1.5	48.0	36.0	24	32	26.0	32.0	21.700
SO 6092-18-3/4	218.2401.648	200	26 x 1.5	50.0	38.0	24	32	26.0	34.0	24.800
SO 6092-20-1/2	218.2401.706	200	26 x 1.5	50.0	36.0	24	32	26.0	33.0	21.700
SO 6092-20-3/4	218.2401.708	200	26 x 1.5	52.0	38.0	24	32	26.0	35.0	24.810
SO 6092-22-3/4	218.2401.768	160	30 x 2	52.0	40.0	27	36	28.0	37.0	28.800
SO 6092-25-1	218.2401.810	160	33 x 2	57.0	44.0	30	41	30.0	40.0	43.900
SO 6092-28-1	218.2401.850	160	36 x 2	56.0	46.0	36	41	32.0	40.0	39.400

# Winkel-Schottverschraubung

## Coude pour passage de cloison

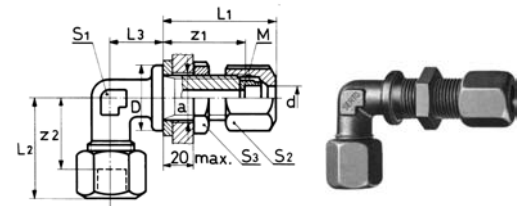
### Panel mount elbow union



## SO 6093

Type -d	Mat.-Nr.	bar	M	L1	L2	L3	a	S2	S3	z1	z2	kg/100
Für metrische Rohre	Pour tubes métriques			For metric tubes								
SO 6093-6	218.2700.060	400	12 x 1.5	44.0	29.0	14.0	14.0	14	17	35.0	20.0	7.100
SO 6093-8	218.2700.080	300	14 x 1.5	44.0	31.0	17.0	16.0	17	19	35.0	22.0	9.600
SO 6093-10	218.2700.100	250	16 x 1.5	47.0	34.0	18.0	18.0	19	22	36.0	23.0	13.500
SO 6093-12	218.2700.120	250	18 x 1.5	50.0	38.0	20.0	20.0	22	24	37.0	25.0	17.800
SO 6093-14	218.2700.140	250	22 x 1.5	52.0	42.0	23.0	24.0	27	30	39.0	29.0	31.000
SO 6093-15	218.2700.150	200	22 x 1.5	52.0	42.0	23.0	24.0	27	30	39.0	29.0	29.600
SO 6093-16	218.2700.160	200	24 x 1.5	54.0	46.0	24.0	26.0	30	32	39.0	31.0	39.000
SO 6093-18	218.2700.180	200	26 x 1.5	57.0	48.0	24.0	28.0	32	36	41.0	32.0	44.300
SO 6093-20	218.2700.200	200	26 x 1.5	59.0	51.0	24.0	28.0	32	36	41.0	32.0	45.700
SO 6093-22	218.2700.220	160	30 x 2	59.0	52.0	30.0	32.0	36	41	44.0	37.0	57.200

Sechskantmutter siehe SO 6310

Ecrou à six pans voir SO 6310

Hexagon nut see SO 6310

# Einstellbare Winkelverschraubung

## Coude orientable

### Adjustable elbow union

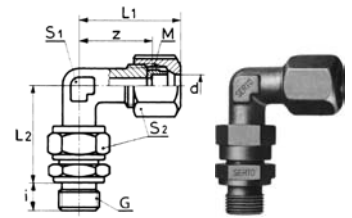

## SO 6095

Typ -d -G	Mat.-Nr.	bar	M	L1	L2	i	S1	S2	z	kg/100
Für metrische Rohre	Pour tubes métriques			For metric tubes						
G=Rohrgewinde (zylindrisch)	G=Filetage-gaz BSP (cylindrique)			G=BSP thread (straight)						
SO 6095-6-1/8	218.2641.100	400	12 x 1.5	29.0	33.0	8.0	12	14	20.0	5.000
SO 6095-8-1/4	218.2641.170	300	14 x 1.5	31.0	37.0	12.0	12	17	22.0	8.100
SO 6095-10-1/4	218.2641.270	250	16 x 1.5	34.0	38.0	12.0	14	19	23.0	10.400
SO 6095-12-3/8	218.2641.390	250	18 x 1.5	38.0	41.0	12.0	17	22	25.0	14.800
SO 6095-14-1/2	218.2641.504	250	22 x 1.5	42.0	47.0	14.0	19	27	29.0	25.300
SO 6095-15-1/2	218.2641.534	200	22 x 1.5	42.0	47.0	14.0	19	27	29.0	25.300
SO 6095-16-1/2	218.2641.566	200	24 x 1.5	46.0	50.0	14.0	22	30	31.0	31.500
SO 6095-18-1/2	218.2641.646	200	26 x 1.5	48.0	51.0	14.0	24	32	32.0	35.000
SO 6095-18-3/4	218.2641.648	200	26 x 1.5	50.0	53.0	16.0	24	32	34.0	38.000
SO 6095-20-1/2	218.2641.706	200	26 x 1.5	50.0	51.0	14.0	24	32	33.0	35.000
SO 6095-20-3/4	218.2641.708	200	26 x 1.5	52.0	53.0	16.0	24	32	35.0	38.000
SO 6095-22-3/4	218.2641.768	160	30 x 2	52.0	57.0	16.0	27	36	37.0	47.200
SO 6095-25-1	218.2641.810	160	33 x 2	57.0	63.0	18.0	30	41	40.0	72.000
SO 6095-28-1	218.2641.850	160	36 x 2	56.0	63.0	18.0	36	41	40.0	69.200

Die einstellbare Winkelverschraubung SO 6095 ist eine Kombination aus dem einstellbaren Anschluss SO 6335 und der Winkelverschraubung SO 6090. Der einstellbare Anschluss SO 6335 ist nur lose montiert.

Le coude orientable SO 6095 est une combinaison du raccordement orientable SO 6335 et du coude SO 6090. Le raccordement orientable SO 6335 est livré monté sans être serré.

The adjustable elbow union SO 6095 is a combination of the adjustable connection SO 6335 and the elbow union SO 6090. The adjustable connection SO 6335 is fitted only loosely.

## Drosselfreie Schwenkverschraubung Coude banjo à passage non réduit Non-throttling single banjo

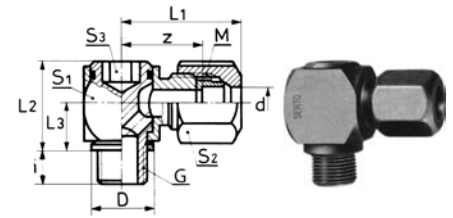

### SO 6096

Typ -d -G	Mat.-Nr.	bar	M	L1	L2	L3	i	S1	S2	S3	z	kg/100
Für metrische Rohre	Pour tubes métriques		For metric tubes									
G=Rohrgewinde (zylindrisch)	G=Filetage-gaz BSP (cylindrique)		G=BSP thread (straight)									
SO 6096-6-1/8	218.2841.100	400	12 x 1.5	29.0	22.0	12.0	8.0	18	14	6	20.0	6.100
SO 6096-8-1/4	218.2841.170	300	14 x 1.5	31.0	28.0	16.0	12.0	22	17	8	22.0	10.200
SO 6096-10-1/4	218.2841.270	250	16 x 1.5	34.0	28.0	16.0	12.0	22	19	8	23.0	11.600
SO 6096-12-3/8	218.2841.390	250	18 x 1.5	38.0	33.0	18.0	12.0	27	22	10	26.0	19.300
SO 6096-14-1/2	218.2841.504	250	22 x 1.5	41.0	37.0	20.0	14.0	30	27	12	28.0	27.800
SO 6096-15-1/2	218.2841.534	200	22 x 1.5	41.0	37.0	20.0	14.0	30	27	12	28.0	27.800
SO 6096-16-1/2	218.2841.566	200	24 x 1.5	44.0	39.0	21.0	14.0	32	30	14	29.0	32.000
SO 6096-18-1/2	218.2841.646	200	26 x 1.5	45.0	39.0	21.0	14.0	32	32	14	29.0	33.300
SO 6096-18-3/4	218.2841.648	200	26 x 1.5	51.0	48.0	26.0	16.0	41	32	17	34.0	56.300
SO 6096-20-1/2	218.2841.706	200	26 x 1.5	47.0	39.0	21.0	14.0	32	32	14	30.0	33.300
SO 6096-20-3/4	218.2841.708	200	26 x 1.5	53.0	48.0	26.0	16.0	41	32	17	35.0	56.300
SO 6096-22-3/4	218.2841.768	160	30 x 2	52.0	48.0	26.0	16.0	41	32	17	37.0	60.200
SO 6096-25-1	218.2841.810	160	33 x 2	58.0	55.0	29.0	18.0	46	36	22	41.0	88.100
SO 6096-28-1	218.2841.850	160	36 x 2	55.0	55.0	29.0	18.0	46	41	22	39.0	79.400

## Drosselfreie Schwenkverschraubung METR Coude banjo à passage non réduit METR Non-throttling single banjo METR

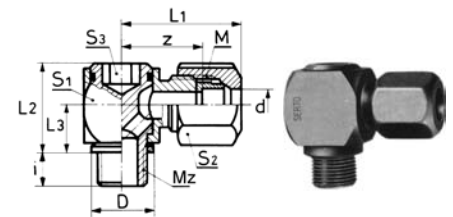

### SO 6096 METR

Type -d -Mz	Mat.-Nr.	bar	M	L1	L2	L3	i	S1	S2	S3	z	kg/100
Für metrische Rohre	Pour tubes métriques		For metric tubes									
Mz=metrisches Gewinde (zylindrisch)	Mz=Filetage métrique (cylindrique)		Mz=Metric thread (straight)									
SO 6096-6-M10X1	218.2843.180	400	12 x 1.5	29.0	22.0	12.0	8.0	18	14	6	20.0	6.100
SO 6096-8-M12X1,5	218.2843.240	300	14 x 1.5	30.0	25.0	15.0	12.0	20	17	6	21.0	9.500
SO 6096-10-M14X1,5	218.2843.280	250	16 x 1.5	34.0	28.0	16.0	12.0	22	19	8	23.0	12.000
SO 6096-12-M16X1,5	218.2843.330	250	18 x 1.5	38.0	33.0	18.0	12.0	27	22	10	26.0	19.300
SO 6096-14-M18X1,5	218.2843.380	250	22 x 1.5	41.0	37.0	20.0	12.0	30	27	12	28.0	26.400
SO 6096-15-M18X1,5	218.2843.390	200	22 x 1.5	41.0	37.0	20.0	12.0	30	27	12	28.0	26.400
SO 6096-18-M22X1,5	218.2843.460	200	26 x 1.5	45.0	39.0	21.0	14.0	32	32	14	29.0	33.700
SO 6096-20-M22X1,5	218.2843.500	200	26 x 1.5	47.0	39.0	21.0	14.0	32	32	14	30.0	33.700
SO 6096-22-M26X1,5	218.2843.535	160	30 x 2	52.0	48.0	26.0	16.0	41	32	17	37.0	59.700
SO 6096-25-M33X2	218.2843.550	160	33 x 2	58.0	55.0	26.0	18.0	46	36	22	41.0	88.100
SO 6096-28-M33X2	218.2843.570	160	36 x 2	55.0	55.0	29.0	18.0	46	41	22	39.0	79.000

O-Ring aus Perbunan, mit einer Härte von ca. 75° Shore. Andere Materialien auf Anfrage.  
Betriebstemperaturen -20°C bis +80°C

Joint torique en perbunan, dureté Shore 75° environ. Autres matériaux sur demande.  
Température de service -20°C à +80°C

O-ring of P grade elastomere of hardness about Shore 75° Sh. Other materials on request.  
Operating temperature -20°C to +80°C

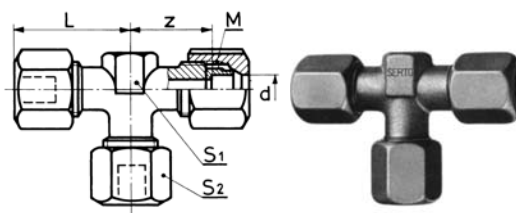
**T-Verschraubung**
**Té**
**Tee union**

**SO 6130**

Type -d	Mat.-Nr.	bar	M	L	S1	S2	z	kg/100
Für metrische Rohre	Pour tubes métriques			For metric tubes				
SO 6130-6	218.3000.060	400	12 x 1.5	29.0	12	14	20.0	6.600
SO 6130-8	218.3000.080	300	14 x 1.5	31.0	12	17	22.0	8.900
SO 6130-10	218.3000.100	250	16 x 1.5	34.0	14	19	23.0	13.700
SO 6130-12	218.3000.120	250	18 x 1.5	38.0	17	22	25.0	18.400
SO 6130-14	218.3000.140	250	22 x 1.5	42.0	19	27	29.0	32.800
SO 6130-15	218.3000.150	200	22 x 1.5	42.0	19	27	29.0	32.800
SO 6130-16	218.3000.160	200	24 x 1.5	46.0	22	30	31.0	42.700
SO 6130-18	218.3000.180	200	26 x 1.5	50.0	24	32	32.0	49.800
SO 6130-20	218.3000.200	200	26 x 1.5	51.0	24	32	33.5	51.300
SO 6130-22	218.3000.220	160	30 x 2	52.0	27	36	37.0	63.700
SO 6130-25	218.3000.250	160	33 x 2	58.0	30	41	40.0	93.400
SO 6130-28	218.3000.280	160	36 x 2	56.0	36	41	40.0	86.600

# Einstellbare T-Verschraubung

## Té orientable

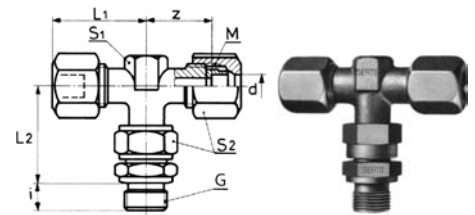
### Adjustable tee union

**SO 6135**

Typ -d -G	Mat.-Nr.	bar	M	L1	L2	i	S1	S2	z	kg/100
Für metrische Rohre	Pour tubes métriques		For metric tubes							
G=Rohrgewinde (zylindrisch)	G=Filetage-gaz BSP (cylindrique)		G=BSP thread (straight)							
SO 6135-8-1/4	218.3651.170	300	14 x 1.5	31.0	37.0	12.0	12	17	22.0	11.000
SO 6135-10-1/4	218.3651.270	250	16 x 1.5	34.0	38.0	12.0	14	19	23.0	15.100
SO 6135-12-3/8	218.3651.390	250	18 x 1.5	38.0	41.0	12.0	17	22	25.0	20.500
SO 6135-14-1/2	218.3651.504	250	22 x 1.5	42.0	47.0	14.0	19	27	29.0	36.500
SO 6135-15-1/2	218.3651.534	200	22 x 1.5	42.0	47.0	14.0	19	27	29.0	36.500
SO 6135-16-1/2	218.3651.566	200	24 x 1.5	46.0	50.0	14.0	22	30	31.0	46.000
SO 6135-18-1/2	218.3651.646	200	26 x 1.5	48.0	51.0	14.0	24	32	32.0	52.300
SO 6135-18-3/4	218.3651.648	200	26 x 1.5	50.0	53.0	16.0	24	32	34.0	55.500
SO 6135-20-1/2	218.3651.706	200	26 x 1.5	50.0	51.0	14.0	24	32	33.0	52.300
SO 6135-20-3/4	218.3651.708	200	26 x 1.5	52.0	53.0	16.0	24	32	35.0	55.500
SO 6135-22-3/4	218.3651.768	160	30 x 2	52.0	57.0	16.0	27	36	37.0	68.500
SO 6135-25-1	218.3651.810	160	33 x 2	57.0	63.0	18.0	30	41	40.0	104.000
SO 6135-28-1	218.3651.850	160	36 x 2	56.0	63.0	18.0	36	41	40.0	97.000

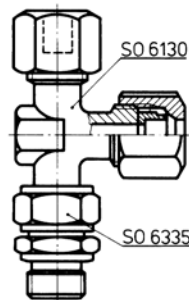
**Anwendungsbeispiele:**
**Exemples d'utilisation:**
**Sample combinations:**

Die einstellbare T-Verschraubung SO 6135 ist eine Kombination aus einstellbarem Anschluss SO 6335 und T-Verschraubung SO 6130.

Le té orientable SO 6135 est une combinaison du raccordement orientable SO 6335 et du té SO 6130.

The adjustable tee union SO 6135 is a combination of the adjustable connection SO 6335 and the tee union SO 6130.

Der einstellbare Anschluss SO 6335 ist nur lose montiert und kann gegen den SERTO-Anschluss SO 6372 und SO 6374 ausgetauscht werden.

Le raccordement orientable SO 6335 est livré monté sans être serré. Il peut être remplacé par l'écrou de raccordement SERTO SO 6372/ SO 6374.

The adjustable connection SO 6335 is fitted only loosely and can be replaced by the SERTO connection SO 6372/6374.

Weitere Kombinationen sind mit der reduzierten T-Verschraubung SO 6130 möglich.

D'autres combinaisons sont possibles avec le té réduit SO 6130.

Further combinations can be obtained with the tee reduction union SO 6130.

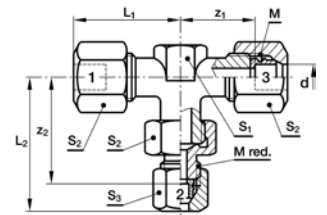
**T-Verschraubung reduziert**
**Té réduit**
**Tee reduction union**

**SO 6139**

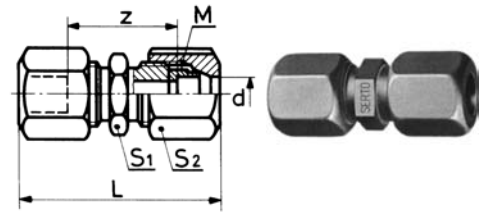
Type -d1 -d2 -d3	Mat.-Nr.	bar	M	M red.	L1	L2	S1	S2	S3	z2	z1	kg/100
SO 6139-12-8-12	218.3009.210	250	18 x 1.5	14 x 1.5	38.0	49.0	17	22	17	40.0	25.0	19.200
SO 6139-14-8-14	218.3009.320	250	22 x 1.5	14 x 1.5	42.0	53.0	19	27	17	44.0	29.0	32.800
SO 6139-14-10-14	218.3009.334	250	22 x 1.5	16 x 1.5	42.0	56.0	19	27	19	45.0	29.0	34.000
SO 6139-15-8-15	218.3009.393	200	22 x 1.5	14 x 1.5	42.0	53.0	19	27	17	44.0	29.0	32.800
SO 6139-15-10-15	218.3009.410	200	22 x 1.5	16 x 1.5	42.0	56.0	19	27	19	45.0	29.0	34.000
SO 6139-18-8-18	218.3009.568	200	26 x 1.5	14 x 1.5	48.0	57.0	24	32	17	48.0	32.0	48.200
SO 6139-18-15-18	218.3009.628	200	26 x 1.5	22 x 1.5	48.0	62.0	24	32	27	49.0	32.0	53.500

**Gerade Verschraubung**
**Union double**
**Straight union**

**SO 6240**

Type -d	Mat.-Nr.	bar	M	L	S1	S2	z	kg/100
Für metrische Rohre	Pour tubes métriques			For metric tubes				
SO 6240-6	218.1020.060	400	12 x 1.5	43.0	12	14	26.0	3.600
SO 6240-8	218.1020.080	300	14 x 1.5	45.0	14	17	27.0	5.300
SO 6240-10	218.1020.100	250	16 x 1.5	50.0	17	19	29.0	8.100
SO 6240-12	218.1020.120	250	18 x 1.5	55.0	19	22	30.0	11.200
SO 6240-14	218.1020.140	250	22 x 1.5	58.0	24	27	32.0	18.800
SO 6240-15	218.1020.150	200	22 x 1.5	58.0	24	27	32.0	18.800
SO 6240-16	218.1020.160	200	24 x 1.5	62.0	24	30	33.0	25.300
SO 6240-18	218.1020.180	200	26 x 1.5	95.0	27	32	33.0	27.800
SO 6240-20	218.1020.200	200	26 x 1.5	69.0	27	32	34.0	28.500
SO 6240-22	218.1020.220	160	30 x 2	69.0	32	36	39.0	36.200
SO 6240-25	218.1020.250	160	33 x 2	77.0	36	41	43.0	55.800
SO 6240-28	218.1020.280	160	36 x 2	72.0	41	41	40.0	44.300
SO 6240-30	218.1020.300	160	39 x 2	84.0	41	46	49.0	71.000

# Reduziernippel

## Réduction femelle-mâle

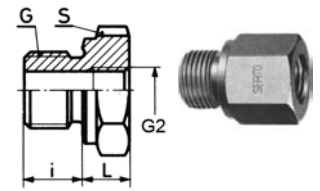
### Male reduction nipple



### SO 6241

Type -G -G2	Mat.-Nr.	L	i	S	kg/100
G=Rohrgewinde (zylindrisch)	G=Filetage-gaz BSP (cylindrique)			G=BSP thread (straight)	
G2=Rohrgewinde (zylindrisch)	G2=Filetage-gaz BSP (cylindrique)			G2=BSP thread (straight)	
SO 6241-1/4-1/8	216.0441.102	14.0	12.0	19.0	3.400
SO 6241-3/8-1/4	216.0441.164	20.0	12.0	22.0	5.700
SO 6241-1/2-1/4	216.0441.224	10.0	14.0	27.0	5.600
SO 6241-1/2-3/8	216.0441.226	21.0	14.0	27.0	8.900
SO 6241-3/4-1/4	216.0441.284	10.0	16.0	32.0	10.100
SO 6241-3/4-3/8	216.0441.286	10.0	16.0	32.0	8.800
SO 6241-3/4-1/2	216.0441.288	24.0	16.0	32.0	13.300
SO 6241-1-1/2	216.0441.408	11.0	18.0	41.0	15.400
SO 6241-1-3/4	216.0441.412	28.0	18.0	41.0	26.600
SO 6241-1/8K-1/4	216.0411.044	21.0	8.0	19.0	3.300
SO 6241-1/4-3/8	216.0441.106	21.0	12.0	22.0	4.500
SO 6241-3/8-1/2	216.0441.168	25.0	12.0	27.0	7.700
SO 6241-1/2-3/4	216.0441.232	29.0	14.0	32.0	18.500
SO 6241-3/4-1	216.0441.296	32.0	16.0	41.0	19.600

#### Anwendungsbeispiele:

#### Exemples d'utilisation:

#### Sample combinations:

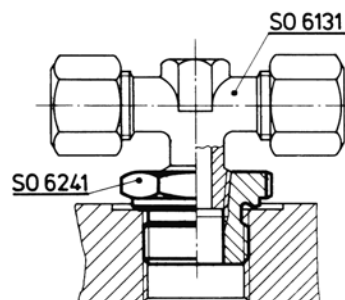

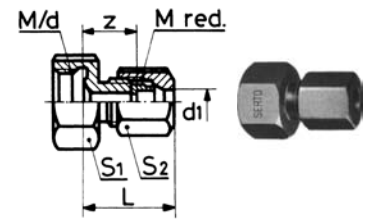

**Reduzier-Verschraubung**
**Union de réduction**
**Reduction union**

**SO 6248**

Type - d - d1	Mat.-Nr.	bar	M	M red.	L	S1	S2	z	kg/100
Für metrische Rohre	Pour tubes métriques		For metric tubes						
SO 6248-8-6	218.1203.140	300	14 x 1.5	12 x 1.5	24.0	17	14	15.0	2.800
SO 6248-10-6	218.1203.175	250	16 x 1.5	12 x 1.5	24.0	19	14	15.0	3.200
SO 6248-10-8	218.1203.190	250	16 x 1.5	14 x 1.5	24.0	19	17	15.0	3.900
SO 6248-12-5	218.1203.210	200	18 x 1.5	12 x 1.5	25.0	22	14	16.0	3.900
SO 6248-12-6	218.1203.215	250	18 x 1.5	12 x 1.5	25.0	22	14	16.0	3.900
SO 6248-12-8	218.1203.225	250	18 x 1.5	14 x 1.5	25.0	22	17	16.0	4.700
SO 6248-12-10	218.1203.240	250	18 x 1.5	16 x 1.5	26.0	22	19	17.0	6.100
SO 6248-15-8	218.1203.400	200	22 x 1.5	14 x 1.5	25.0	27	17	16.0	6.400
SO 6248-15-10	218.1203.410	200	22 x 1.5	16 x 1.5	28.0	27	19	17.0	7.600
SO 6248-15-12	218.1203.420	200	22 x 1.5	18 x 1.5	30.0	27	22	17.0	8.400
SO 6248-16-10	218.1203.470	200	24 x 1.5	16 x 1.5	28.0	30	19	17.0	8.700
SO 6248-16-12	218.1203.480	200	24 x 1.5	18 x 1.5	30.0	30	22	17.0	10.000
SO 6248-16-14	218.1203.500	200	24 x 1.5	22 x 1.5	31.0	30	27	18.0	13.200
SO 6248-18-8	218.1203.570	200	26 x 1.5	14 x 1.5	26.0	32	17	17.0	8.400
SO 6248-18-10	218.1203.575	200	26 x 1.5	16 x 1.5	28.0	32	19	17.0	9.100
SO 6248-18-12	218.1203.580	200	26 x 1.5	18 x 1.5	30.0	32	22	17.0	10.400
SO 6248-18-14	218.1203.600	200	26 x 1.5	22 x 1.5	31.0	32	27	18.0	13.700
SO 6248-18-15	218.1203.610	200	26 x 1.5	22 x 1.5	31.0	32	27	18.0	13.700
SO 6248-22-12	218.1203.730	160	30 x 2	18 x 1.5	31.0	36	22	18.0	12.600
SO 6248-22-14	218.1203.740	160	30 x 2	22 x 1.5	31.0	36	27	18.0	15.300
SO 6248-22-15	218.1203.745	160	30 x 2	22 x 1.5	31.0	36	27	18.0	15.300
SO 6248-22-18	218.1203.755	160	30 x 2	26 x 1.5	35.0	36	32	19.0	19.100

Stahl

Acier

Steel

**Sechskantmutter**

**Ecrou à six pans**

**Hexagon nut**

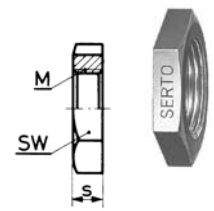

**SO 6310**

Type -M	Mat.-Nr.	SW	s	kg/100
SO 6310-M12X1,5	216.0063.195	17	6.00	0.700
SO 6310-M14X1,5	216.0063.225	19	6.00	0.800
SO 6310-M16X1,5	216.0063.265	22	6.00	1.100
SO 6310-M18X1,5	216.0063.305	24	6.00	1.100
SO 6310-M22X1,5	216.0063.375	30	7.00	2.200
SO 6310-M24X1,5	216.0063.405	32	7.00	2.400
SO 6310-M26X1,5	216.0063.435	36	8.00	3.500
SO 6310-M30X2	216.0063.470	41	8.00	4.500

Sechskantmutter für SO 6093 und SO 6333

Ecrou à six pans pour SO 6093 et SO 6333

Hexagon nut for SO 6093 and SO 6333

## Gerade Einschraubverschraubung

mit Dichtkante

### Union mâle

ave arête d'étanchéité

### Male adaptor union

with edge seal

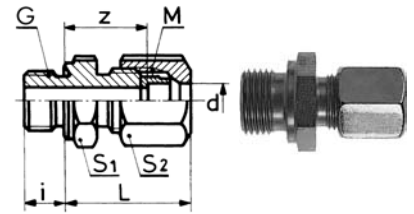

## SO 6331

Type - d - G	Mat.-Nr.	bar	M	L	i	S1	S2	z	kg/100
Für metrische Rohre	Pour tubes métriques		For metric tubes						
G=Rohrgewinde (zylindrisch)	G=Filetage-gaz BSP (cylindrique)		G=BSP thread (straight)						
SO 6331-6-1/8	218.1141.100	400	12 x 1.5	25.0	8.0	14	14	16.5	2.500
SO 6331-6-1/4	218.1141.110	400	12 x 1.5	27.0	12.0	19	14	18.0	3.900
SO 6331-8-1/4	218.1141.170	300	14 x 1.5	27.0	12.0	19	17	18.0	4.500
SO 6331-10-1/4	218.1141.270	250	16 x 1.5	30.0	12.0	19	19	19.0	5.800
SO 6331-10-3/8	218.1141.280	250	16 x 1.5	31.0	12.0	22	19	20.5	7.500
SO 6331-10-1/2	218.1141.285	250	16 x 1.5	32.0	14.0	27	19	21.0	8.900
SO 6331-12-1/4	218.1141.380	250	18 x 1.5	32.0	12.0	19	22	19.0	7.250
SO 6331-12-3/8	218.1141.390	250	18 x 1.5	33.0	12.0	22	22	20.5	8.500
SO 6331-12-1/2	218.1141.400	250	18 x 1.5	34.0	14.0	27	22	21.0	11.200
SO 6331-14-3/8	218.1141.502	250	22 x 1.5	35.0	12.0	22	27	21.5	11.800
SO 6331-14-1/2	218.1141.504	250	22 x 1.5	35.0	14.0	27	27	22.0	13.700
SO 6331-15-3/8	218.1141.532	200	22 x 1.5	35.0	12.0	22	27	21.5	11.800
SO 6331-15-1/2	218.1141.534	200	22 x 1.5	35.0	14.0	27	27	22.0	14.200
SO 6331-16-1/2	218.1141.566	200	24 x 1.5	38.0	14.0	27	30	23.0	17.000
SO 6331-18-1/2	218.1141.646	200	26 x 1.5	39.0	14.0	27	32	23.0	17.900
SO 6331-18-3/4	218.1141.648	200	26 x 1.5	39.0	16.0	32	32	24.0	21.300
SO 6331-18-1	218.1141.652	200	26 x 1.5	40.0	18.0	41	32	24.0	29.660
SO 6331-20-1/2	218.1141.706	200	26 x 1.5	41.0	14.0	27	32	23.5	17.900
SO 6331-20-3/4	218.1141.708	200	26 x 1.5	42.0	16.0	32	32	25.0	21.600
SO 6331-20-1	218.1141.712	200	26 x 1.5	41.0	18.0	41	32	24.5	29.880
SO 6331-22-3/4	218.1141.768	160	30 x 2	41.0	16.0	32	36	26.0	24.200
SO 6331-22-1	218.1141.770	160	30 x 2	42.0	18.0	41	36	27.0	33.500
SO 6331-25-1	218.1141.810	160	33 x 2	46.0	18.0	41	41	29.0	40.600
SO 6331-28-1	218.1141.850	160	36 x 2	43.0	18.0	41	41	27.0	33.200
SO 6331-30-1	218.1141.900	160	39 x 2	50.0	18.0	41	46	32.0	44.600
SO 6331-30-1-1/4	218.1141.902	160	39 x 2	52.0	20.0	50	46	34.0	58.500

## Gerade Einschraubverschraubung R

mit Dichtkante

### Union mâle R

ave arête d'étanchéité

### Male adaptor union R

with edge seal

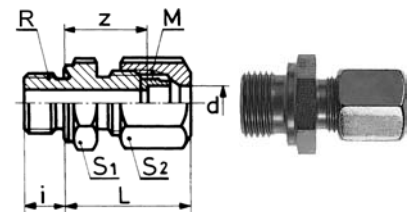

## SO 6331 R

Type - d - R	Mat.-Nr.	bar	M	L	i	S1	S2	z	kg/100
Für metrische Rohre	Pour tubes métriques		For metric tubes						
R=Rohrgewinde (kegelig)	R=Filetage-gaz BSP (conique)		R=BSP thread (tapered)						
SO 6331-8-1/8K	218.1101.160	300	14 x 1.5	27.0	5.0	14	17	19.0	3.200

k=kegeliges Einschraubgewinde  
d=Rohrussen-ø  
L= Mass in montiertem Zustand

k=filetage mâle conique  
d=ø extérieur du tube  
L=après montage

k=tapered male adaptor thread  
d=tube outside diameter  
L=installed length



# Verschraubung mit Anschlussmuffe

## Union femelle

## Female adaptor union

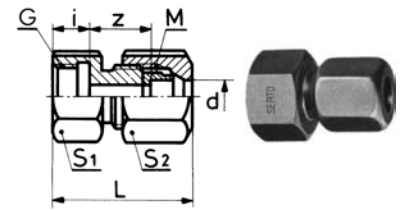

### SO 6332

Type - d - G	Mat.-Nr.	bar	M	L	i	S1	S2	z	kg/100
Für metrische Rohre	Pour tubes métriques								
G=Rohrgewinde (zylindrisch)	G=Filetage-gaz BSP (cylindrique)								
SO 6332-6-1/8	218.1201.100	400	12 x 1.5	31.0	8.0	14	14	14.0	2.500
SO 6332-6-1/4	218.1201.110	400	12 x 1.5	36.0	12.0	19	14	15.0	4.200
SO 6332-6-3/8	218.1201.120	400	12 x 1.5	47.0	12.0	22	14	17.0	4.800
SO 6332-6-1/2	218.1201.125	400	12 x 1.5	42.0	14.0	27	14	19.0	8.700
SO 6332-8-1/4	218.1201.170	300	14 x 1.5	35.0	12.0	19	17	14.0	4.700
SO 6332-8-1/2	218.1201.185	300	14 x 1.5	37.0	14.0	27	17	14.0	6.900
SO 6332-10-1/4	218.1201.270	250	16 x 1.5	38.0	12.0	19	19	15.0	6.100
SO 6332-10-3/8	218.1201.280	250	16 x 1.5	38.0	12.0	22	19	15.0	6.800
SO 6332-10-1/2	218.1201.285	250	16 x 1.5	40.0	14.0	27	19	15.0	8.400
SO 6332-12-1/4	218.1201.380	250	18 x 1.5	40.0	12.0	19	22	15.0	7.700
SO 6332-12-3/8	218.1201.390	250	18 x 1.5	41.0	12.0	22	22	16.0	7.900
SO 6332-12-1/2	218.1201.400	250	18 x 1.5	42.0	14.0	27	22	15.0	9.500
SO 6332-14-1/2	218.1201.504	250	22 x 1.5	44.0	14.0	27	27	17.0	13.200
SO 6332-15-1/2	218.1201.534	200	22 x 1.5	44.0	14.0	27	27	17.0	13.200
SO 6332-16-1/2	218.1201.566	200	24 x 1.5	46.0	14.0	27	30	17.0	15.600
SO 6332-18-1/2	218.1201.646	200	26 x 1.5	47.0	14.0	27	32	17.0	17.500
SO 6332-18-3/4	218.1201.648	200	26 x 1.5	50.0	16.0	32	32	18.0	19.100
SO 6332-20-1/2	218.1201.706	200	26 x 1.5	49.0	14.0	27	32	18.0	17.500
SO 6332-20-3/4	218.1201.708	200	26 x 1.5	52.0	16.0	32	32	19.0	19.100
SO 6332-22-3/4	218.1201.768	160	30 x 2	51.0	16.0	32	36	20.0	23.000
SO 6332-25-1	218.1201.810	160	33 x 2	56.0	18.0	41	41	23.0	36.900
SO 6332-28-1	218.1201.850	160	36 x 2	55.0	18.0	41	41	21.0	30.200
SO 6332-30-1	218.1201.900	160	39 x 2	65.0	20.0	41	46	27.0	35.890

#### Anwendungsbeispiele:

#### Exemples d'utilisation:

#### Sample combinations:

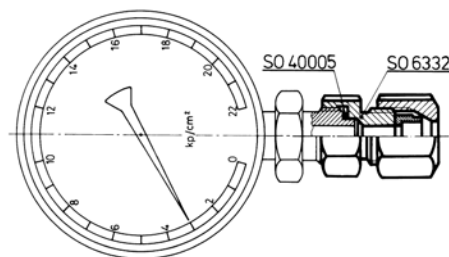

Stahl

Acier

Steel

## Gerade Schottverschraubung

Durchführungslänge max 20 mm

## Union double pour passage de cloison

pour cloison max. 20 mm

## Panel mount union

max. panel thickness 20 mm

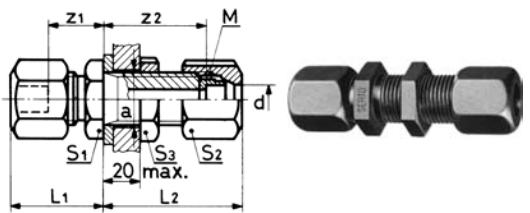

**SO 6333**

Type-d	Mat.-Nr.	bar	M	L1	L2	a	S1	S2	S3	z2	z1	kg/100
Für metrische Rohre	Pour tubes métriques			For metric tubes								
SO 6333-6	218.1500.060	400	12 x 1.5	24.0	44.0	14.0	17	14	17	35.0	15.0	6.200
SO 6333-8	218.1500.080	300	14 x 1.5	25.0	44.0	16.0	19	17	19	35.0	16.0	8.500
SO 6333-10	218.1500.100	250	16 x 1.5	29.0	47.0	18.0	22	19	22	36.0	18.0	12.500
SO 6333-12	218.1500.120	250	18 x 1.5	31.0	50.0	20.0	24	22	24	37.0	18.0	16.100
SO 6333-14	218.1500.140	250	22 x 1.5	33.0	52.0	24.0	27	27	30	39.0	20.0	27.300
SO 6333-15	218.1500.150	200	22 x 1.5	33.0	52.0	24.0	27	27	30	39.0	20.0	26.700
SO 6333-16	218.1500.160	200	24 x 1.5	36.0	54.0	26.0	30	30	32	39.0	21.0	35.000
SO 6333-18	218.1500.180	200	26 x 1.5	38.0	57.0	28.0	32	32	36	41.0	22.0	41.000
SO 6333-20	218.1500.200	200	26 x 1.5	41.0	60.0	28.0	32	32	36	43.0	24.0	41.000
SO 6333-22	218.1500.220	160	30 x 2	41.0	59.0	32.0	36	36	41	44.0	26.0	52.200

Sechskantmutter siehe SO 6310

Ecrou à six pans voir SO 6310

Hexagon nut see SO 6310

# Einstellbarer Anschluss

## Raccordement orientable

### Adjustable connection

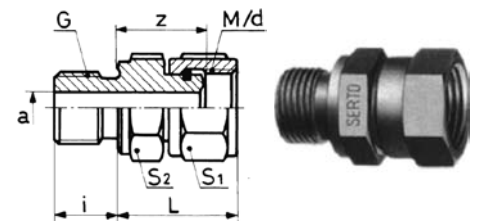

## SO 6335

Type -d-G	Mat.-Nr.	bar	M	L	a	i	S1	S2	z	kg/100
Für metrische Rohre	Pour tubes métriques		For metric tubes							
G=Rohrgewinde (zylindrisch)	G=Filetage-gaz BSP (cylindrique)		G=BSP thread (straight)							
SO 6335-6-1/8	218.1651.100	250	12 x 1.5	20.0	4.0	8.0	14	14	14.0	2.000
SO 6335-8-1/4	218.1651.170	250	14 x 1.5	22.0	6.0	12.0	17	17	16.0	3.500
SO 6335-10-1/4	218.1651.270	200	16 x 1.5	24.0	7.0	12.0	19	19	16.0	4.100
SO 6335-12-3/8	218.1651.390	200	18 x 1.5	25.0	9.0	12.0	22	22	17.0	6.000
SO 6335-14-1/2	218.1651.504	160	22 x 1.5	28.0	11.0	14.0	27	27	19.0	10.200
SO 6335-15-1/2	218.1651.534	160	22 x 1.5	28.0	11.0	14.0	27	27	19.0	10.200
SO 6335-16-1/2	218.1651.566	160	24 x 1.5	29.0	12.0	14.0	30	27	20.0	12.100
SO 6335-18-1/2	218.1651.646	160	26 x 1.5	31.0	14.0	14.0	32	30	21.0	12.500
SO 6335-18-3/4	218.1651.648	160	26 x 1.5	29.0	16.0	16.0	32	32	20.0	14.500
SO 6335-20-1/2	218.1651.706	160	26 x 1.5	31.0	14.0	14.0	32	30	21.0	12.500
SO 6335-20-3/4	218.1651.708	160	26 x 1.5	29.0	16.0	16.0	32	32	20.0	14.500
SO 6335-22-3/4	218.1651.768	160	30 x 2	32.0	18.0	16.0	36	36	22.0	17.700
SO 6335-25-1	218.1651.810	160	33 x 2	37.0	20.0	18.0	41	41	25.0	30.000
SO 6335-28-1	218.1651.850	160	36 x 2	35.0	23.0	18.0	41	41	25.0	24.800

### Anwendungsbeispiele:

### Exemples d'utilisation:

### Sample combinations:

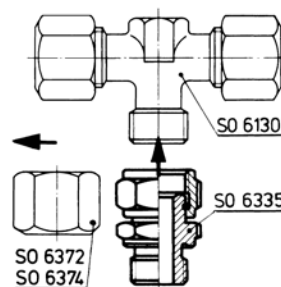

Die angedrehte Dichtkante am Einstellnippel drückt sich bei der Montage in das Gegenstück ein und dichtet metallisch ab.

L'arête d'étanchéité de l'union orientable s'enfonce au montage dans la contre-pièce et forme un joint métallique parfait.

The integrally turned sealing edge on the adjusting nipple bites into the mating part on assembly, forming a metal/metal seal.

d=Kenngröße: entspricht dem Rohraussen- $\varnothing$  des SERTO-Anschlusses SO 6372 und SO 6374, der gegen den einstellbaren Anschluss SO 6335 ausgetauscht werden kann.

d=dimension nominale: correspond au  $\varnothing$  extérieur du tube de l'écrou de raccordement SO 6372/SO 6374, lequel peut être échangé contre le raccordement orientable SO 6335.

d=Nominal size: corresponds to tube outside dia. of the SERTO connection SO 6372/6374 which could be replaced by the adjustable connection SO 6335.

## Einstellbarer Anschluss Raccordement orientable Adjustable connection

### SO 6335 G

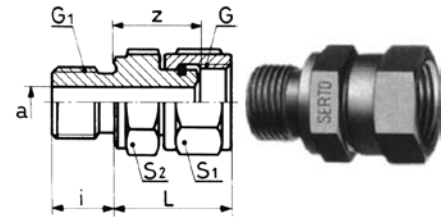

Type -G-G1	Mat.-Nr.	bar	L	a	i	S1	S2	z	kg/100
G=Rohrgewinde (zylindrisch)	G=Filetage-gaz BSP (cylindrique)	G=BSP thread (straight)							
SO 6335-1/8-1/8	218.1655.042	250	20.0	4.0	8.0	14	14	14.0	2.000
SO 6335-1/4-1/4	218.1655.104	250	22.0	6.0	12.0	17	17	16.0	3.500
SO 6335-3/8-3/8	218.1655.166	200	24.0	9.0	12.0	22	22	16.0	6.000
SO 6335-1/2-1/2	218.1655.228	160	28.0	11.0	14.0	27	27	19.0	10.200

## Einstellbarer Anschluss METR Raccordement orientable METR Adjustable connection METR

### SO 6335 METR

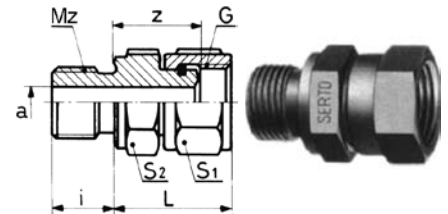

Type -G-Mz	Mat.-Nr.	bar	L	a	i	S1	S2	z	kg/100
Mz=metrisches Gewinde (zylindrisch)	Mz=Filetage métrique (cylindrique)	Mz=Metric thread (straight)							
SO 6335-1/8-M10X1	218.1656.040	250	20.0	4.0	8.0	14	14	14.0	2.500
SO 6335-1/4-M12X1,5	218.1656.085	250	22.0	6.0	12.0	17	17	16.0	3.500
SO 6335-3/8-M16X1,5	218.1656.150	200	24.0	9.0	12.0	22	22	19.0	5.500
SO 6335-1/2-M18X1,5	218.1656.180	160	28.0	11.0	12.0	27	27	20.0	9.500

#### Anwendungsbeispiele:

#### Exemples d'utilisation:

#### Sample combinations:

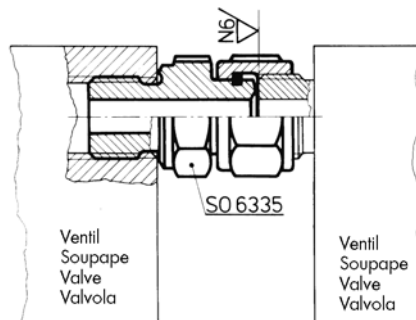

Direkte Verbindung von verschiedenen Aggregaten möglich ohne Verwendung von Röhren. Kompakte Bauweise, schnelle Montage, einfache Fixierung der Aggregate in die gewünschte Stellung.

Der Gewindezapfen für das Gewinde G muss zylindrisch sein und eine plane Auflagefläche haben.

Beachten Sie auch die Möglichkeiten mit SO 6345.

Die angedrehte Dichtkante am Einstellnippel drückt sich bei der Montage in das Gegenstück ein und dichtet metallisch ab.

Raccordement direct de différents éléments possible sans recours à des tuyaux. Construction compacte, montage rapide, fixation simple des éléments en position désirée.

L'embout fileté pour filetage G doit être cylindrique et présenter une face d'appui plane.

Voir également les possibilités avec SO 6345.

L'arête d'étanchéité de l'union orientable s'enfonce au montage dans la contre-pièce et forme un joint métallique parfait.

Direct inter-connection of various appliances possible without the use of tubes. Compact construction, quick assembly, and easy fixing of the appliances in the desired position.

The threaded stem for the thread G must be straight, and have a plane seating surface.

See SO 6345 for additional possibilities.

The integrally turned sealing edge on the adjusting nipple bites into the mating part on assembly, forming a metal/metal seal.





# Einstellbare Kupplung

## Raccord orientable

### Adjustable coupling

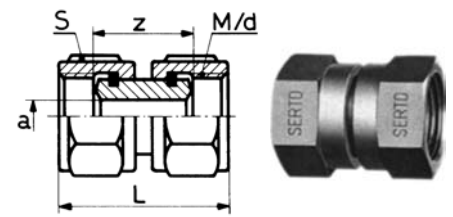

## SO 6345

Type-d	Mat.-Nr.	bar	M	L	a	S	z	kg/100
Für metrische Rohre	Pour tubes métriques			For metric tubes				
SO 6345-6	218.1350.060	250	12 x 1.5	27.0	4.0	14.0	15.0	1.980
SO 6345-8	218.1350.080	250	14 x 1.5	27.0	6.0	17.0	15.0	2.920
SO 6345-10	218.1350.100	200	16 x 1.5	30.0	7.0	19.0	15.0	3.820
SO 6345-12	218.1350.120	200	18 x 1.5	31.0	9.0	22.0	15.0	5.000
SO 6345-14	218.1350.140	160	22 x 1.5	37.0	11.0	27.0	19.0	9.130
SO 6345-15	218.1350.150	160	22 x 1.5	37.0	11.0	27.0	19.0	9.130
SO 6345-18	218.1350.180	160	26 x 1.5	37.0	14.0	32.0	19.0	13.000
SO 6345-20	218.1350.200	160	26 x 1.5	37.0	14.0	32.0	19.0	13.000
SO 6345-22	218.1350.220	160	30 x 2	39.0	18.0	36.0	19.0	16.100

### Anwendungsbeispiele:

### Exemples d'utilisation:

### Sample combinations:

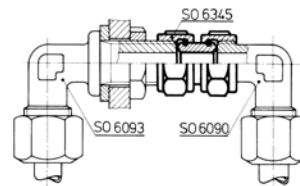
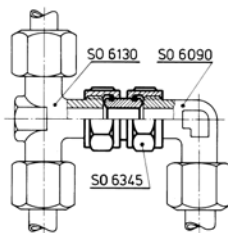

Beachten Sie auch die Möglichkeiten mit SO 6335.

Die angedrehten Dichtkanten an der Einstellbuchse drücken sich bei der Montage in das Gegenstück ein und dichten metallisch ab.

d=Kenngröße: entspricht dem Rohraussen- $\varnothing$  des SERTO-Anschlusses SO 6372 und SO 6374, der gegen die einstellbare Kupplung SO 6345 ausgetauscht werden kann.

Voir également les possibilités avec SO 6335.

Les arêtes d'étanchéité de la douille orientable s'enfoncent au montage dans la contre-pièce et forment un joint métallique parfait.

d=dimension nominale: correspond au  $\varnothing$  extérieur du tube de l'écrou de raccordement SO 6372/ SO 6374, lequel peut être échangé contre le raccord orientable SO 6345.

See SO 6335 for additional possibilities.

The integrally turned sealing edges on the adjusting sleeve bite into the mating parts on assembly, forming a metal/metal seal.

d=Nominal size: corresponds to tube outside dia. of the SERTO connection SO 6372/ SO 6374 which could replace the adjustable coupling SO 6345.

## Einstellbare Kupplung

### Raccord orientable

### Adjustable coupling

#### SO 6345 G

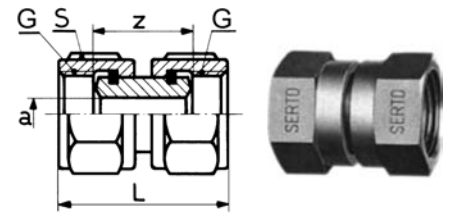

Type -G	Mat.-Nr.	bar	L	a	S	z	kg/100
Für metrische Rohre							
G=Rohrgewinde (zylindrisch)							
SO 6345-1/8	218.1361.020	250	27.0	4.0	14.0	15.0	2.350
SO 6345-1/4	218.1361.040	250	27.0	6.0	17.0	15.0	3.020
SO 6345-3/8	218.1361.060	200	31.0	9.0	22.0	15.0	5.320
SO 6345-1/2	218.1361.080	160	38.0	11.0	27.0	19.0	9.880

## Einstellbare Kupplung

### Raccord orientable

### Adjustable coupling

#### SO 6345 G d

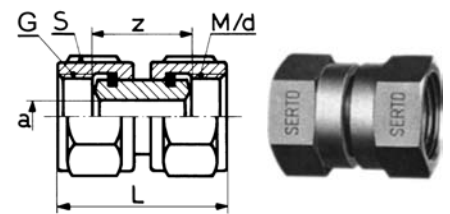

Type -G -d	Mat.-Nr.	bar	M	L	a	S	z	kg/100
Für metrische Rohre								
G=Rohrgewinde (zylindrisch)								
SO 6345-1/8-6	218.1371.100	250	12 x 1.5	27.0	4.0	14.0	15.0	2.160
SO 6345-1/4-8	218.1371.220	250	14 x 1.5	27.0	6.0	17.0	15.0	2.950
SO 6345-3/8-12	218.1371.340	200	18 x 1.5	31.0	9.0	22.0	15.0	5.170
SO 6345-1/2-14	218.1371.380	160	22 x 1.5	38.0	11.0	27.0	19.0	9.490
SO 6345-1/2-15	218.1371.400	160	22 x 1.5	38.0	11.0	27.0	19.0	9.490

Fortsetzung nächste Seite

Suite à la prochaine page

Continued on next page

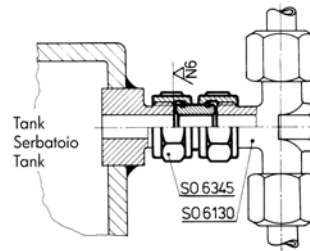
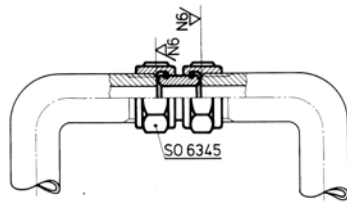
**Anwendungsbeispiele:**
**Exemples d'utilisation:**
**Sample combinations:**

Direkte Verbindung von verschiedenen Aggregaten möglich ohne Verwendung von Rohren. Kompakte Bauweise, schnelle Montage, einfache Fixierung der Aggregate in die gewünschte Stellung.

Raccordement direct de différents éléments possible sans recours à des tuyaux. Construction compacte, montage rapide, fixation simple des éléments en position désirée.

Direct inter-connection of various appliances possible without the use of tubes. Compact construction, quick assembly, and easy fixing of the appliances in the desired position.

Beachten Sie auch die Möglichkeiten mit SO 6335.

Voir également les possibilités avec SO 6335.

See SO 6335 for additional possibilities.

Der Gewindezapfen für das Gewinde G muss zylindrisch sein und eine plane Auflagefläche haben.

L'embout fileté pour filetage G doit être cylindrique et présenter une face d'appui plane.

The threaded stem for the thread G must be straight, and have a plane sealing surface.

Die angedrehten Dichtkanten an der Einstellbuchse drücken sich bei der Montage in das Gegenstück ein und dichten metallisch ab.

Les arêtes d'étanchéité de l'union orientable s'enfoncent au montage dans la contre-pièce et forment un joint métallique parfait.

The integrally turned sealing edges on the adjusting sleeve bites into the mating parts on assembly, forming a metal/metal seal.

d=Kenngröße: entspricht dem Rohraußen- $\varnothing$  des SERTO-Anschlusses SO 6372 und SO 6374, der gegen die einstellbare Kupplung SO 6345 ausgetauscht werden kann.

d=dimension nominale: correspond au  $\varnothing$  extérieur du tube de l'écrou de raccordement SO 6372/ SO 6374, lequel peut être échangé contre le raccord orientable SO 6345.

d=Nominal size: corresponds to tube outside dia. of the SERTO connection SO 6372/ SO 6374 which could replace the adjustable coupling SO 6345.

# Klemmring

## Bague de serrage

### Compression ferrule

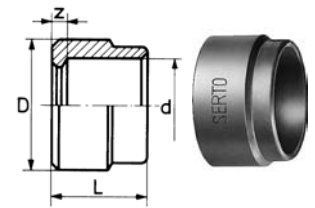

### SO 6372

Type -d	Mat.-Nr.	bar	L	D	z	kg/100
Für metrische Rohre	Pour tubes métriques			For metric tubes		
SO 6372-6	216.0010.060	400	6.5	8.2	1.0	0.100
SO 6372-8	216.0010.080	300	7.0	10.2	1.0	0.140
SO 6372-10	216.0010.100	250	8.0	13.0	1.0	0.290
SO 6372-12	216.0010.120	250	9.0	15.0	1.0	0.380
SO 6372-14	216.0010.140	250	10.0	17.0	1.0	0.520
SO 6372-15	216.0010.150	200	10.0	18.0	1.0	0.540
SO 6372-16	216.0010.160	200	11.0	19.0	1.0	0.660
SO 6372-18	216.0010.180	200	12.0	21.0	1.0	0.880
SO 6372-20	216.0010.200	200	12.0	23.7	1.5	1.140
SO 6372-22	216.0010.220	160	12.5	26.0	2.0	1.300
SO 6372-25	216.0010.250	160	13.5	30.0	1.5	1.850
SO 6372-28	216.0010.280	160	13.0	32.0	2.0	1.700
SO 6372-30	216.0010.300	160	14.5	35.0	2.0	2.380

Stahl

Acier

Steel

## Anschlussmutter

Ecrou

Union nut

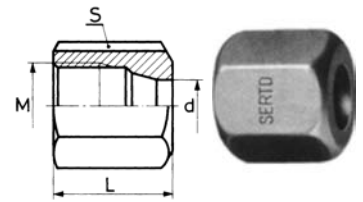

### SO 6374

Type -d	Mat.-Nr.	bar	M	L	S	kg/100
Für metrische Rohre	Pour tubes métriques			For metric tubes		
SO 6374-6	216.0200.060	250	12 x 1.5	16.0	14.0	0.950
SO 6374-8	216.0200.080	300	14 x 1.5	16.0	17.0	1.500
SO 6374-10	216.0200.100	250	16 x 1.5	19.0	19.0	2.400
SO 6374-12	216.0200.120	250	18 x 1.5	21.0	22.0	3.500
SO 6374-14	216.0200.140	250	22 x 1.5	22.0	27.0	5.900
SO 6374-15	216.0200.150	200	22 x 1.5	22.0	27.0	5.900
SO 6374-16	216.0200.160	200	24 x 1.5	24.0	30.0	8.100
SO 6374-18	216.0200.180	200	26 x 1.5	25.0	32.0	9.200
SO 6374-20	216.0200.200	200	26 x 1.5	26.0	32.0	9.200
SO 6374-22	216.0200.220	160	30 x 2	26.0	36.0	11.500
SO 6374-25	216.0200.250	160	33 x 2	30.0	41.0	17.700
SO 6374-28	216.0200.280	160	36 x 2	27.0	41.0	12.700
SO 6374-30	216.0200.300	160	39 x 2	33.0	46.0	21.400

## Anschlussnippel

Ecrou mâle

Nipple connection

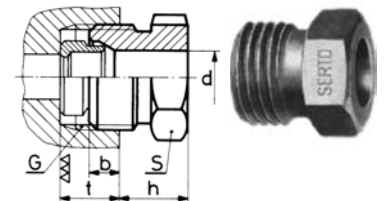

### SO 6377

Type -d -G	Mat.-Nr.	bar	b	h	S	t	kg/100
G=Rohrgewinde (zylindrisch)	G=Filetage-gaz BSP (cylindrique)				G=BSP thread (straight)		
SO 6377-6-1/4	216.0911.110	400	6.0	9.0	14.0	8.0	1.200
SO 6377-6-1/4	216.0911.114	400	8.0	9.0	14.0	11.0	1.300
SO 6377-8-1/4	216.0911.160	300	7.0	9.0	14.0	11.0	1.000
SO 6377-8-3/8	216.0911.182	300	9.0	10.0	17.0	12.0	2.000

SO 6377-8-1/4 =  
nur für Rohre mit Wanddicke 1 mm

SO 6377-8-1/4 =  
seulement pour tubes avec paroi de 1 mm

SO 6377-8-1/4 =  
for tubes with wall thickness of 1 mm only

Bitte beachten:  
Die jeweils dazugehörigen Klemmringe  
SO 6372 müssen separat bestellt werden.

Remarque:  
Les bagues de serrage correspondantes SO  
6372 doivent être commandées séparément dans  
chaque cas

Please note:  
The relevant compression ferrules SO 6372  
must be ordered separately